

CHAPTER 3

THE CREATINE KINASE PHOSPHOTRANSFER NETWORK: THERMODYNAMIC AND KINETIC CONSIDERATIONS, THE IMPACT OF THE MITOCHONDRIAL OUTER MEMBRANE AND MODELLING APPROACHES

VALDUR SAKS^{1,2}, TUULI KAAMBRE², RITA GUZUN¹, TIIA ANMANN², PEETER SIKK², UWE SCHLATTNER^{1,3}, THEO WALLIMANN³, MAYIS ALIEV⁴ AND MARKO VENDELIN⁵

¹Laboratory of Fundamental and Applied Bioenergetics, INSERM U 884, Joseph Fourier University, 2280, Rue de la Piscine, BP53X – 38041, Grenoble Cedex 9, France

²Laboratory of Bioenergetics, National Institute of Chemical Physics and Biophysics, Akadeemia tee 23, 12618 Tallinn, Estonia

³Institute of Cell Biology, ETH-Zurich, Höggerberg HPM D24, Schafmattstrasse 18, CH-8093 Zurich, Switzerland

⁴Cardiology Research Center, Institute of Experimental Cardiology, Laboratory of Cardiac Pathology, 121552 Moscow, Russia

⁵Department of Mechanics and Applied Mathematics, Institute of Cybernetics, Tallinn Technical University, Akadeemia tee 21, 12618 Tallinn, Estonia

Abstract: In this review, we summarize the main structural and functional data on the role of the phosphocreatine (PCr) – creatine kinase (CK) pathway for compartmentalized energy transfer in cardiac cells. Mitochondrial creatine kinase, MtCK, fixed by cardiolipin molecules in the vicinity of the adenine nucleotide translocator, is a key enzyme in this pathway. Direct transfer of ATP and ADP between these proteins has been revealed both in experimental studies on the kinetics of the regulation of mitochondrial respiration and by mathematical modelling as a main mechanism of functional coupling of PCr production to oxidative phosphorylation. In cells *in vivo* or in permeabilized cells *in situ*, this coupling is reinforced by limited permeability of the outer membrane of the mitochondria for adenine nucleotides due to the contacts with cytoskeletal proteins. Due to these mechanisms, at least 80% of total energy is exported from mitochondria by PCr molecules. Mathematical modelling of intracellular diffusion and energy transfer shows that the main function of the PCr – CK pathway is to connect different pools (compartments) of ATP and, by this way, to overcome the local restrictions and diffusion limitation of adenine nucleotides due to the high degree of structural organization of cardiac cells

1. GENERAL DESCRIPTION OF THE CREATINE KINASE SYSTEM IN MUSCLE CELLS

High work requirements and the unique contractile function of the heart have made cardiac muscle the most intensively studied object in bioenergetics. Among other items, the role of the creatine kinase (CK) system has been thoroughly studied in cardiac cells during several decades in many laboratories. In this review, we summarize the data regarding the role of the CK system in heart, with the aim to emphasize the most important evidences of functioning of this system. Its role is equally important both in skeletal and smooth muscle, in brain, and in many other types of cells, as described elsewhere (Wallimann and Hemmer, 1994; Ames, 2000).

Energy metabolism of cardiac cells is based on aerobic oxidation of fatty acids and carbohydrate substrates, coupled to ATP production by mitochondrial oxidative phosphorylation (Neely and Morgan, 1974; Williamson *et al.*, 1979; Opie, 1998; Stanley *et al.*, 2005; Taegtmeyer *et al.*, 2005). Then, the energy is supplied to the sites of its utilization via structurally and functionally organized phosphotransfer networks (Wallimann *et al.*, 1992; Dzeja and Terzic, 2003; Saks *et al.*, 1994, 2006a). The cardiac cell is structurally and functionally highly ordered, with very regular crystal-like arrangement of mitochondria and a unitary (modular) nature of energy metabolism (Saks *et al.*, 2001; Seppet *et al.*, 2001; Vendelin *et al.*, 2005; Weiss *et al.*, 2006), organized into intracellular energetic units, ICEUs (Figure 1). All CK isoenzymes are compartmentalized in the cells, within these ICEUs. Mitochondrial isoforms of CK were discovered in Klingenberg's laboratory in 1964 (Klingenberg, 1964), shortly after the discovery of the cytosolic MM- and BB-CK isoforms (see Eppenberger *et al.*, 1967). In muscle cells, significant fractions of the MM isozyme are connected structurally to the myofibrils, to the membrane of sarcoplasmic reticulum (SR) and to the sarcolemma (Wallimann *et al.*, 1992, 1998; Dzeja *et al.*, 1998; Wyss and Kaddurah-Daouk, 2000; Dzeja and Terzic, 2003; Bessman and Geiger, 1981; Scholte, 1973; Saks *et al.*, 1974, 1977, 2006b; Sharov *et al.*, 1977; Wallimann and Hemmer, 1994; Schlegel *et al.*, 1988a; Haas and Strauss, 1990; Fritz-Wolf *et al.*, 1996; Qin *et al.*, 1998; Schlattner *et al.*, 2000; Burklen *et al.*, 2006). This intracellular compartmentation of the CK isozymes forms the structural basis for an energy transfer network – the so-called phosphocreatine (PCr) circuit. Below, we first describe the structural evidence for the CK pathway and then the mechanisms of functioning for each of the CK isoenzymes.

2. STRUCTURAL STUDIES

The molecular structure and structure-function relationships of creatine kinase isoenzymes have been studied in much detail by some of us and other groups (Fritz-Wolf *et al.*, 1996; McLeish and Kenyon, 2005; Schlattner *et al.*, 1998; Schlegel *et al.*, 1988b; Schnyder *et al.*, 1994). In particular, the MtCK isoenzymes and their proteolipid complexes have been analyzed by various approaches. This

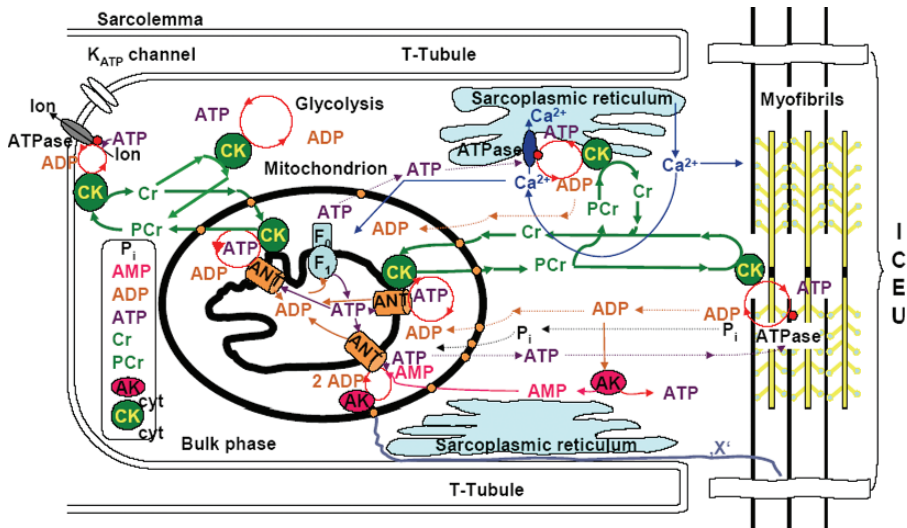

Figure 1. The coupled CK and adenylate kinase (AK) reactions within the intracellular energetic units (ICEUs) in muscle cells. By interaction with cytoskeletal elements, the mitochondria and sarcoplasmic reticulum are precisely fixed with respect to the structure of a sarcomere of myofibrils, i.e. between two Z-lines and, correspondingly, between two T-tubules. Calcium is released from the sarcoplasmic reticulum into the ICEU space in the vicinity of mitochondria and sarcomeres to activate contraction and mitochondrial dehydrogenases. Adenine nucleotides within the ICEU do not equilibrate rapidly with adenine nucleotides in the bulk water phase. ANT is mitochondrial adenine nucleotide translocase, and F_0F_1 is the ATP synthase complex. The mitochondria, sarcoplasmic reticulum, MgATPase of myofibrils as well as ATP-sensitive systems in the sarcolemma are interconnected by metabolic channeling of reaction intermediates and by high-energy phosphate transfer within the ICEU by the CK-PCr system. Protein factors (still unknown and marked as "X"), most probably connected to the cytoskeleton, fix the position of mitochondria and probably also control the permeability of the voltage-dependent anion carrier (VDAC) channels for ADP and ATP. Adenine nucleotides within the ICEU and the bulk water phase may be connected by some more rapidly diffusing metabolites such as Cr and PCr. Synchronization of the functioning of ICEUs within the cell may occur by the same metabolites (for example, P_i or PCr) and/or by synchronized release of calcium during the excitation-contraction coupling process. This scheme is an artwork of Christian Linke, a student of the Erasmus programme.

work has been summarized in several recent reviews (McLeish and Kenyon, 2005; Schlattner *et al.*, 1998, 2006; Schlattner and Wallimann, 2004, 2006; Wallimann *et al.*, 1992). Only a brief summary is given here, and the reader is referred to the cited reviews for a more detailed description and original references.

The solution of atomic structures of all four CK isoenzymes during the last decade, most of them with participation of some of us (Eder *et al.*, 1999, 2000; Fritz-Wolf *et al.*, 1996; Rao *et al.*, 1998), as well as of the transition state structure of a related arginine kinase (Zhou *et al.*, 1998) were an enormous contribution to the field. It allowed for the first time to put earlier data in a structure-function framework and to design new experiments that specifically target CK functions, for

example, the specific association of CK isoenzymes with partner proteins involved in ATP-delivering or -consuming processes.

Mitochondrial creatine kinase differs from cytosolic CK not only by its organellar localization, but also by two important other properties (Figure 2). First, while the cytosolic CK isozymes are strictly dimeric, MtCK forms not only dimers but is able to reversibly associate into highly ordered, cuboidal octamers, the predominant form *in vitro* as well as *in vivo*. Second, octameric MtCK behaves as a peripheral membrane protein, interacting with different protein and lipid components of the mitochondrial membranes.

The MtCK octamer is stabilized *in vivo* by high protein concentrations in the mitochondrial intermembrane space and its binding to mitochondrial membranes. Kinetic and thermodynamic properties of octamer/dimer transitions were suggested as regulatory parameters for energy transduction in mitochondrial intermembrane contact sites. However, octamer/dimer transitions are too slow for fast metabolic adaptations, although they might play a role in long-term adaptations or modulation of energy metabolism. In contrast, octamer/dimer transitions may be crucial in pathological situations (Stachowiak *et al.*, 1998; Schlattner *et al.*, 2006).

Octameric MtCK is characterized by specific membrane-binding properties that are absent or less developed in dimeric MtCK. Also cytosolic CK isoenzymes are mainly soluble, and only a fraction is bound to particular subcellular structures like myofibrils, sarcoplasmic reticulum or plasma membrane (Wallimann *et al.*, 1992). By contrast, octameric MtCK behaves as a typical peripheral membrane protein (Schlattner *et al.*, 2006). It occurs in cristae and the peripheral intermembrane space of mitochondria (Figure 3) and shows a strong affinity for acidic phospholipids, in particular cardiolipin (diphosphatidyl glycerol) in the outer leaflet of the inner membrane, and to mitochondrial porin (VDAC, voltage dependent anion channel) in the outer membrane. Thus, by its size and its binding properties, MtCK can bridge the intermembrane space. There is also good evidence for a functional interaction of MtCK with the transmembrane protein adenine nucleotide translocator (ANT) in the inner mitochondrial membrane. However, the association between these two proteins seems to be indirect and mediated by cardiolipin. Both MtCK and ANT show a high affinity for cardiolipin ($K_D < 100$ nM), which may lead to close co-localization in cardiolipin membrane patches. It is well known that cardiolipin-protein interactions are important for subunit assembly and complex formation of mitochondrial inner membrane proteins. Two recent studies are in full support of the MtCK-cardiolipin-ANT model. In collaboration with Epanand's group, we could show that octameric MtCK can indeed induce cardiolipin clusters in model membranes (Epanand *et al.*, 2007), and that the resulting proteolipid complexes can even play a role in transmembrane lipid transfer (Epanand *et al.*, 2006).

The proteolipid complexes containing octameric MtCK, situated in the peripheral intermembrane space and the cristae (Figure 3), are perfectly suited to sustain the channeling of substrates and products of the reaction, thus avoiding dissipation

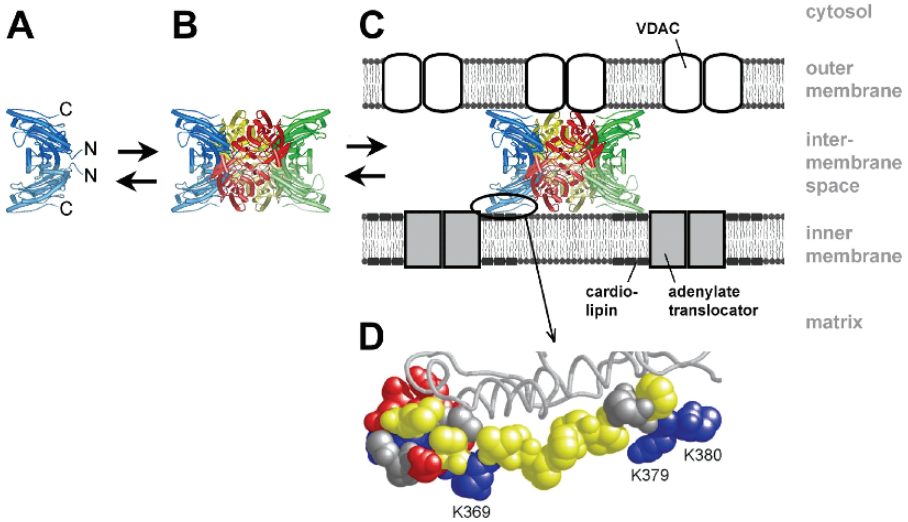

Figure 2. Proteolipid-complex formation of MtCK in the mitochondrial intermembrane space. (A) Nascent MtCK is imported into the mitochondrial intermembrane space, the mitochondrial targeting sequence is cleaved off, and folding is accompanied by assembly into dimers (blue banana-shaped molecule). (B) MtCK dimers rapidly associate into cube-like octamers with four-fold symmetry; this is a reversible association, but octamers are strongly favored at the pH values and MtCK concentrations present at this location. (C) Octameric MtCK binds to both mitochondrial membranes and assembles into proteolipid complexes containing the voltage-dependent anion carrier (VDAC = porin) and the adenine nucleotide transporter (ANT). Principal high-affinity receptors for MtCK are cardiolipin in the inner membrane (black rectangles in the vicinity of ANT) and VDAC together with other anionic phospholipids in the outer membrane. (D) Enlarged C-terminal membrane- (cardiolipin-) binding domain of MtCK, showing the involved basic lysine residues (indicated as K369, K379 and K380 of the C-terminus of MtCK) that bind to acidic phospholipids (cardiolipin). Interaction of MtCK with ANT is most likely indirect and involves common cardiolipin patches (see dark rectangles in the vicinity of ANT in C). Due to the symmetrical nature of the MtCK octamer, MtCK mediates contacts between the inner and outer membrane through four C-terminal proteolipid complexes with the outer membrane and four with the inner membrane, one of them depicted by a circle in C. The membrane-bound state of octameric MtCK is strongly favored by the large membrane interaction surface and the high affinity of MtCK for cardiolipin ($K_D = 80\text{ nM}$) and VDAC ($K_D < 100\text{ nM}$). Binding of dimers to phospholipid membranes occurs with much lower affinity and probably involves association into octamers while bound to the membrane. (A)-(C) show the X-ray structure of chicken sarcomeric MtCK in cartoon representation; each dimer is represented in a different color; (D) shows human sMtCK in space-filling representation with the following amino acid color code: red – acidic, blue – basic, yellow – hydrophobic. Figure modified from Schlattner *et al.*, 2004, 2006; Schlattner and Wallimann, 2006 with kind permission from J. Biol. Chem. and Nova Publishers.

of ATP into the bulk solution and driving the reaction towards phosphocreatine generation (for details see Figure 3). In contrast to octamers, dimeric MtCK has only low affinity to membranes and is much less efficient for cardiolipin clustering and channeling of energy-rich metabolites in mitochondrial contact sites (Epan *et al.*, 2007; Khuchua *et al.*, 1998).

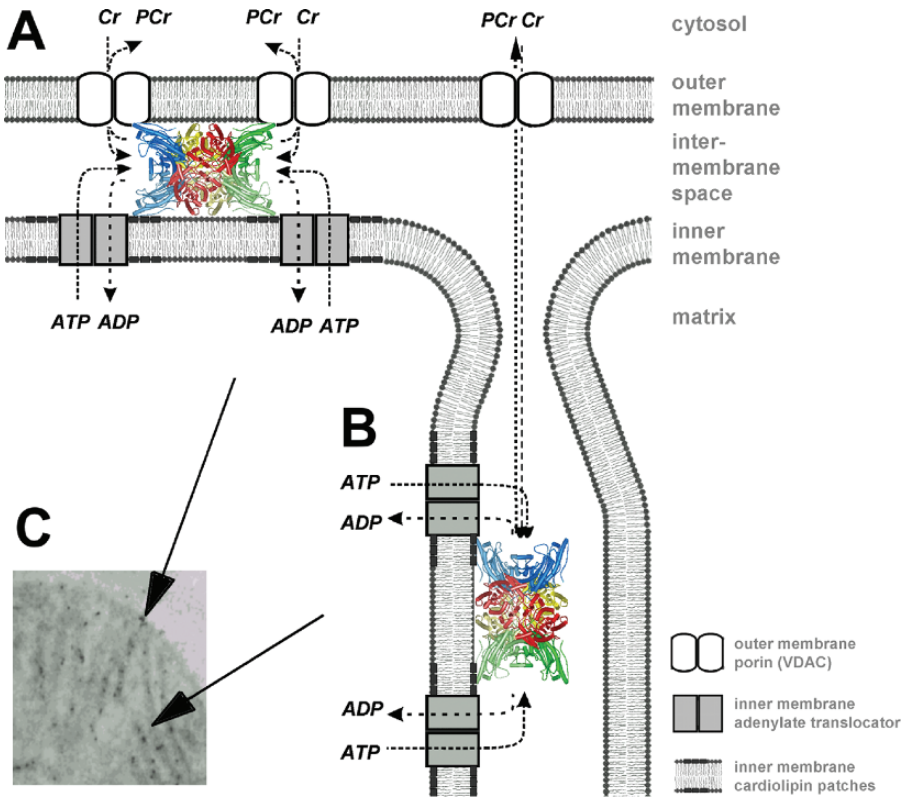

Figure 3. MtCK microcompartments in mitochondria: dual localization of MtCK and putative metabolite routes. MtCK is found at two mitochondrial locations: (A) the peripheral intermembrane space, mainly in so-called mitochondrial contact sites in association with adenine nucleotide transporter (ANT) and voltage-dependent anion carrier (VDAC), as well as (B) along the cristae space in association with ANT only. (C) Visualization by post-embedding immuno-gold labeling of MtCK in a mitochondrion from a photoreceptor cell of chicken retina. The proteolipid complexes assembled by MtCK (see Figure 2) create microcompartments that allow for a direct exchange (called metabolite channeling or functional coupling) of MtCK substrates and products, which is depicted by arrows: (A) In contact sites, octameric MtCK binds simultaneously to inner (IM) and outer mitochondrial membranes (OM), due to the identical top and bottom faces of the octamer. Binding partner in the inner membrane is the two-fold negatively charged cardiolipin, which allows a functional interaction with the ANT that is situated in cardiolipin membrane patches. In the outer membrane, MtCK interacts with other acidic phospholipids and, in a calcium-dependent manner, directly with the pore-forming VDAC. In contact sites, metabolite channeling allows for a constant supply of substrates to and removal of products from the active sites of MtCK. By preventing the dissipation of mitochondrially generated ATP into the cytosol, its energy content is directly transferred by MtCK to creatine to yield phosphocreatine, a metabolically inert compound. Phosphocreatine is then diffusing via VDAC into the cytosol, where it is available to CKs at various locations for *in situ* regeneration of ATP. *Vice versa*, intramitochondrial regeneration of ADP stimulates oxidative phosphorylation. (B) In cristae, ATP/ADP exchange occurs as in contact sites, while creatine and phosphocreatine have to diffuse along the cristae space to reach VDAC. Figure modified from Schlattner and Wallimann, 2004, 2006; Schlattner *et al.*, 2006 with kind permission from J. Biol. Chem. and Nova Publishers.

3. FUNCTIONAL STUDIES

3.1. Mitochondrial Creatine Kinases

In 1939, Belitzer and Tsybakova showed that in muscle homogenates, oxygen consumption was stimulated by creatine (Cr) and resulted in PCr production with a ratio of PCr/O of approximately 3 (Belitzer and Tsybakova, 1939). This result was the earliest indication for a functional coupling between MtCK and oxidative phosphorylation (see below). It is interesting to note that in their experiments on well washed skeletal muscle homogenates, Belitzer and Tsybakova observed strong stimulation of respiration by Cr without addition of exogenous adenine nucleotides. Much later, the same effect was described by Kim and Lee (1987) for isolated pig heart mitochondria and by Dolder *et al.* (2003) for liver mitochondria from transgenic mice expressing active MtCK. The results of these latter studies could be explained by very efficient use of endogenous adenine nucleotides by the coupled MtCK reaction. Bessman and Fonyo (1966) as well as Vial *et al.* (1972) showed in studies on isolated heart muscle mitochondria that in the presence of ATP, addition of Cr significantly increased the state 4 respiration rate. In 1973, Jacobus and Lehninger studied the kinetics of the stimulatory effect of Cr on the state 4 respiration rate and found that at its physiological concentration of 10–15 mM, Cr stimulated the respiration maximally to the state 3 level (Jacobus and Lehninger, 1973). The details of this effective mechanism of PCr production coupled to oxidative phosphorylation in isolated rat heart mitochondria were studied by applying kinetic analysis with some elements of mathematical modelling (Saks *et al.*, 1975; Jacobus and Saks, 1982). The results showed that oxidative phosphorylation controls PCr production in heart mitochondria. When uncoupled from oxidative phosphorylation (if the latter is not activated, for example), the MtCK reaction does not differ kinetically and thermodynamically from other CK isoenzymes: the reaction always favours ATP production and – according to the Haldane relationship – ADP and PCr binding is more effective due to higher affinities than that of ATP and Cr, respectively (Saks *et al.*, 1974, 1975). When the calculated predicted rates of the reaction were compared with the experimental ones, good agreement was seen in the absence of oxidative phosphorylation but not when the latter was activated: under conditions of oxidative phosphorylation, the MtCK reaction was strongly shifted towards PCr synthesis (Saks *et al.*, 1975). This suggested that ATP produced by mitochondrial oxidative phosphorylation is a much more effective substrate for MtCK than exogenous MgATP in the medium, and it was proposed that this is due to direct ANT-mediated transfer of ATP from the matrix space to MtCK, which should be located in close proximity to ANT to make such direct channeling possible (Saks *et al.*, 1975; Jacobus and Saks, 1982).

3.1.1. Kinetic evidence for the functional coupling between MtCK and ANT by direct transfer of ATP

A simple kinetic protocol was developed for demonstration of the mechanism of functional coupling between MtCK and ANT, which is shown in Figure 4 for

isolated mitochondria. In these experiments, isolated mitochondria were incubated in the presence of 10 mM Cr, and the rate of PCr production in the MtCK reaction was measured by either one of two approaches: (i) spectrophotometrically by a coupled enzyme assay (involving phosphoenolpyruvate, pyruvate kinase and lactate dehydrogenase; PEP-PK-LDH) while oxidative phosphorylation was inhibited by rotenone (10 μ M) and oligomycin (1 μ M); or (ii) by measuring the rate of Cr-dependent oxygen consumption, followed by calculation of the rates of PCr production by using experimentally determined P/O ratios (Figure 4A). Figure 4B shows that in the presence of oxidative phosphorylation, the rate of the MtCK reaction in direction of PCr and ADP synthesis is significantly higher than in its absence, due to significantly decreased apparent K_m values for ATP in the CK reaction (Figure 4C) (Saks *et al.*, 1975; Jacobus and Saks, 1982).

To describe better the mechanism of this phenomenon, a complete kinetic analysis of the CK reaction in isolated rat heart mitochondria under both conditions – i.e. with and without oxidative phosphorylation (Jacobus and Saks, 1982) – was found to be very useful and informative. Figure 5 shows the principles and value of this approach. Figure 5A shows the complete kinetic scheme of the CK reaction, assuming a Bi-Bi quasi-equilibrium random-type reaction mechanism, according to Cleland's classification (Cleland, 1963). The rate equation of this reaction is:

$$V = \frac{V_m \cdot [\text{Cr}] \cdot [\text{MgATP}]}{K_{ia} \cdot K_b + K_a \cdot [\text{Cr}] + K_b \cdot [\text{MgATP}] + [\text{Cr}] \cdot [\text{MgATP}]}$$

To determine the values of the dissociation constants for all substrates, the initial rates in both directions (in the absence of products) were determined for six different concentrations of both substrates (Figure 5B and D). The data were analyzed by performing, successively, primary (Figure 5C) and secondary analyses (Figure 5E)

Figure 4. Comparison of normalised CK kinetics in isolated cardiac mitochondria with and without oxidative phosphorylation (\pm ox.phos.), in the presence of 10 mM Cr. MIM, MOM and ANT are mitochondrial inner membrane, mitochondrial outer membrane, and adenine nucleotide transporter, respectively. (A) Scheme of experiments to measure the kinetics of the mitochondrial creatine kinase (MtCK) reaction in isolated cardiac mitochondria. On the left: studies of MtCK kinetics with oxidative phosphorylation; reaction rates were calculated from oxygen consumption rates and P/O ratios. On the right: studies of MtCK kinetics in the absence of oxidative phosphorylation; reaction rates were measured with a coupled enzyme assay (PEP-PK-LDH) after inhibition of the respiratory chain (RC) and ATP synthase by rotenone (10 μ M) and oligomycin (1 μ M), respectively. (B) MtCK kinetics with oxidative phosphorylation (+ox.phos.) were measured by respirometry in mitomed solution (final concentrations: 110 mM sucrose, 60 mM K-lactobionate, 0.5 mM dithiothreitol, 0.5 mM EGTA, 3 mM MgCl₂, 20 mM taurine, 3 mM KH₂PO₄, 20 mM K-HEPES, 5 mM glutamate, 2 mM malate, 2 mg/ml essentially fatty acid free bovine serum albumin and pH = 7.1), followed by normalization of the data (for $V_m = 304 \pm 12$ nmol O₂ · mg protein⁻¹ · min⁻¹). MtCK kinetics in the absence of oxidative phosphorylation (-ox.phos.) were measured in the same medium by spectrophotometry with the system described on the right-hand side of Figure 4A. (C) Normalised MtCK kinetics in double-reciprocal plots for illustrating the decrease in apparent K_m for ATP with oxidative phosphorylation.

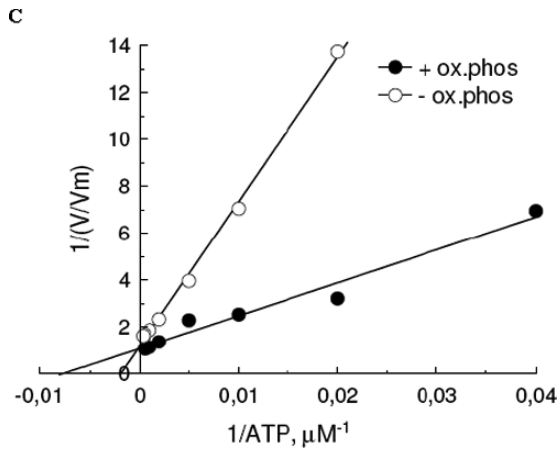
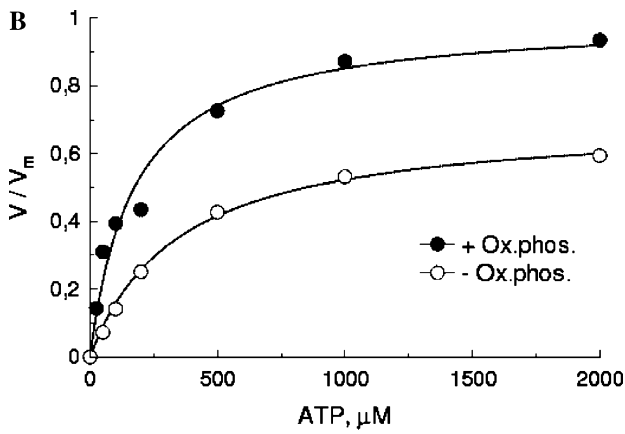
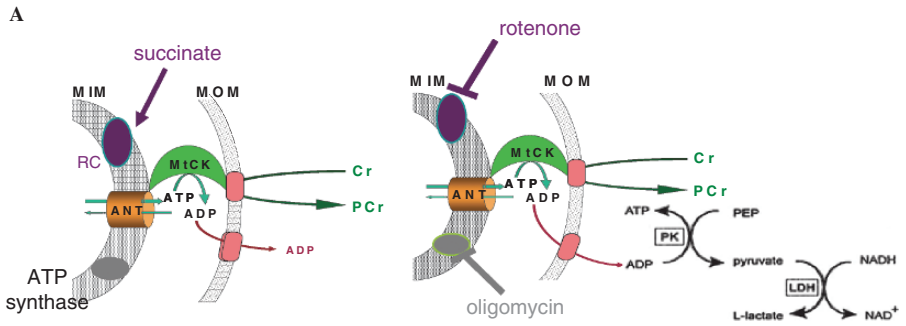

by a simple linearization method in double reciprocal plots, according to the following equations.

$$1/v = \frac{1}{[Cr]} \left(\frac{K_b}{V_m} \left(\frac{K_{ia}}{[MgATP]} + 1 \right) \right) + \frac{1}{V_m} \left(\frac{K_a}{[MgATP]} + 1 \right)$$

This family of straight lines could be used for a secondary analysis of ordinate intercepts, i_o :

$$i_o = \frac{1}{V_m} \left(1 + \frac{K_a}{[MgATP]} \right)$$

or slopes:

$$\text{slope} = \frac{K_b}{V_m} \left(\frac{K_{ia}}{[MgATP]} + 1 \right)$$

to find directly the values of dissociation constants K_a and K_{ia} for MgATP, respectively, as shown in Figure 5F. Similar analysis of $1/v$ versus $1/[MgATP]$ and secondary analysis allowed to determine the dissociation constants for Cr, K_{ib} and K_b (Figure 5G). This linearization method is very illustrative, since secondary analysis directly shows the reciprocal values of the dissociation constants for both substrates, ATP (Figure 5F) and Cr (Figure 5G). While the kinetic constants for guanidino substrates – Cr and PCr – were the same in both conditions, oxidative phosphorylation had a specific effect on the kinetic parameters for adenine nucleotides; in particular, the K_a value was decreased by an order of magnitude. The Haldane relationship for the CK reaction was no longer valid, showing the involvement of some other processes – oxidative phosphorylation and ANT (Jacobus and Saks, 1982). The most likely explanation is the direct transfer of ATP from ANT to MtCK due to their spatial proximity which results also in increased uptake of ADP from MtCK (reversed direct transfer); as a result, the turnover of adenine nucleotides is increased manifold at low external concentrations of MgATP, thereby maintaining high rates of oxidative phosphorylation and coupled PCr production in the presence of high Cr concentrations.

The conclusions of the privileged access of mitochondrial ATP to MtCK and increased mitochondrial turnover of adenine nucleotides in the presence of Cr were directly confirmed by Barbour *et al.* (1984) with the use of an isotopic method, and with a thermodynamic approach by De Furia *et al.* (1980), Saks *et al.* (1985) and Soboll *et al.* (1994). Finally, an effective competitive enzyme method for studying the functional coupling phenomenon, namely the pathway of ADP movement from MtCK back to mitochondria, was developed by Gellerich *et al.* (1982, 1987, 1994, 1998, 2002). These authors used an external PEP-PK system to trap ADP and thus to compete with ANT for this substrate. This competitive enzyme system was never able to suppress more than 50% of Cr-stimulated respiration in isolated heart mitochondria, thereby showing the rather

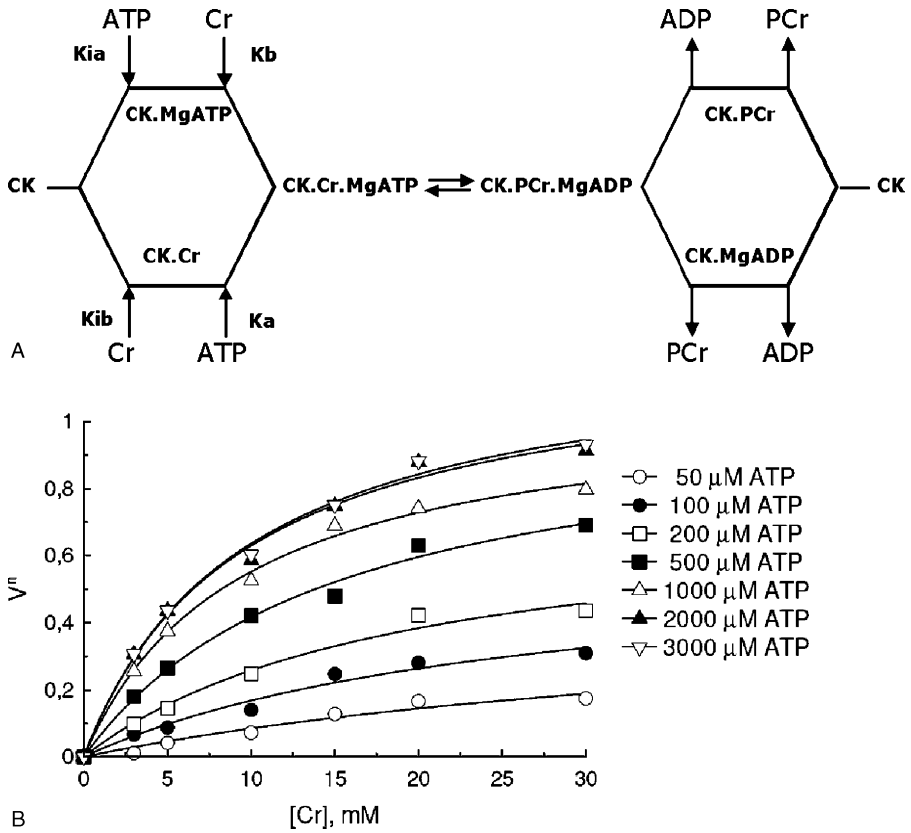
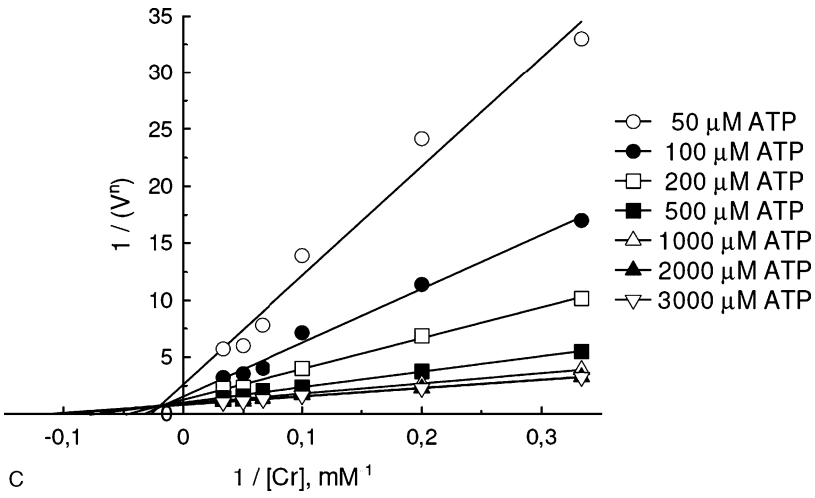
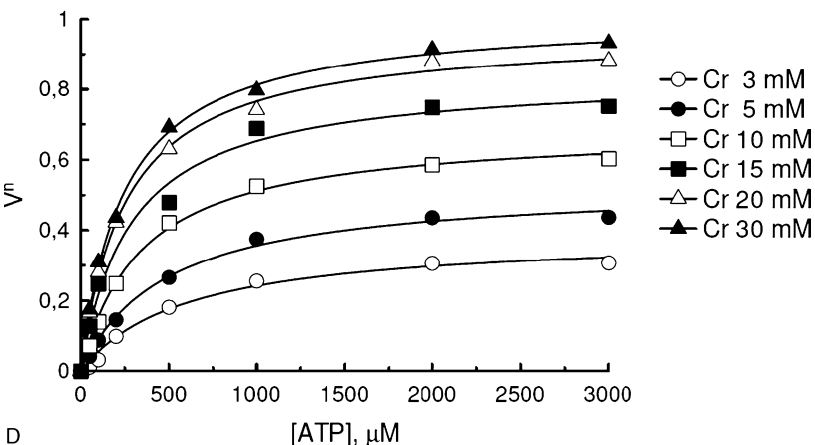

Figure 5. CK kinetics without oxidative phosphorylation in isolated cardiac mitochondria. (A) The complete kinetic scheme of the CK reaction. (B) Initial rates of the MtCK reaction without oxidative phosphorylation as a function of Cr concentration with different fixed ATP concentrations. (C) Secondary analysis of CK kinetics for fixed ATP concentrations, for finding values of i_0 and slopes for calculation of dissociation constants K_b and K_{ib} . (D) Initial rates of the MtCK reaction without oxidative phosphorylation as a function of ATP concentration, when Cr concentrations are fixed. (E) Secondary analysis of CK kinetics for fixed Cr concentrations, for finding values of i_0 and slopes for calculation of dissociation constants K_{ia} and K_a . (F) Determination of kinetic constants for ATP – K_a and K_{ia} – by secondary analysis of data obtained both in the absence (Figure 5E) and presence (not shown) of oxidative phosphorylation. (G) Determination of kinetic constants for Cr – K_b and K_{ib} – by secondary analysis of data obtained both in the absence (Figure 5C) and presence (not shown) of oxidative phosphorylation.



C



D

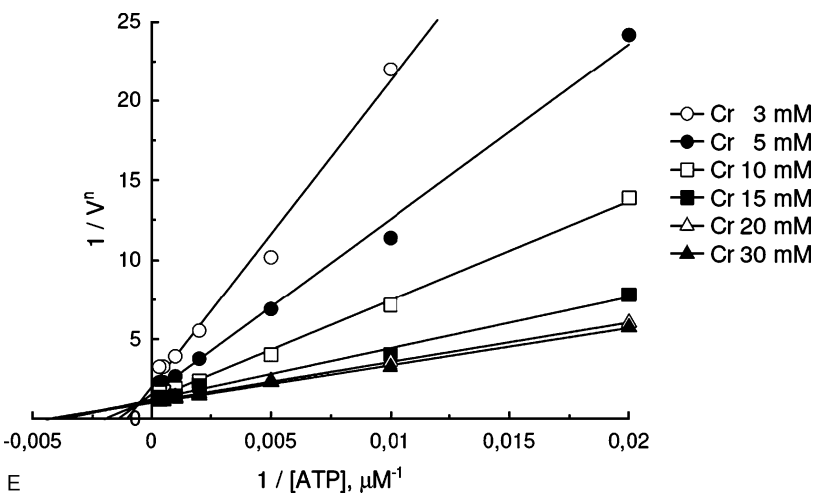

E

Figure 5. (continued)

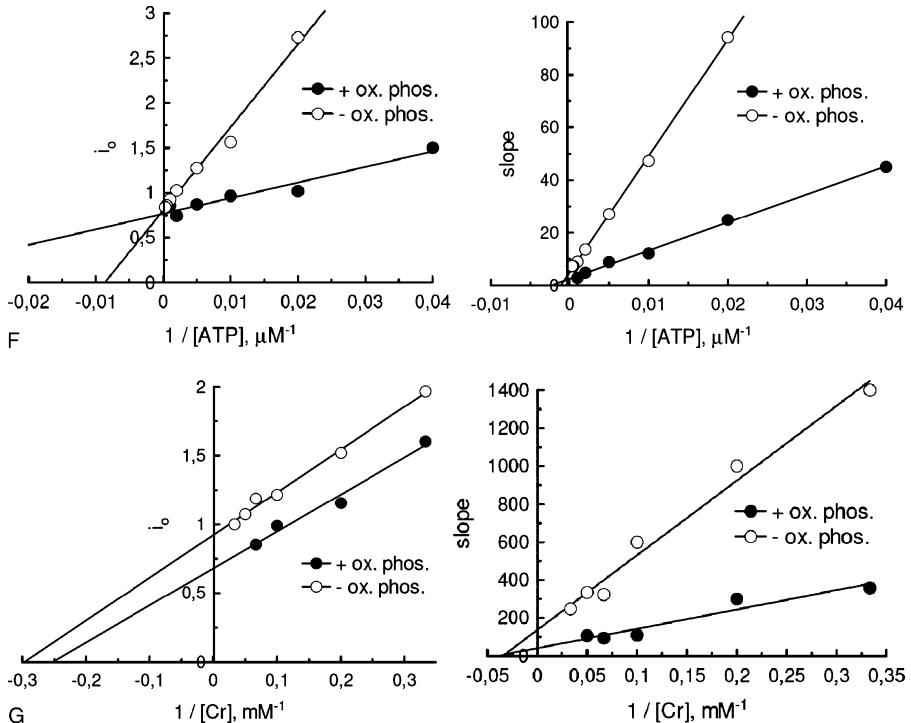

Figure 5. (continued)

effective channelling of ADP from MtCK to the ANT (Gellerich *et al.*, 1982). Gellerich's group has explained these latter data by the hypothesis of dynamic compartmentation of adenine nucleotides in the intermembrane space, meaning that there is some control of the permeability of the outer mitochondrial membrane, which would result in ADP and ATP concentration gradients across this membrane (Gellerich *et al.*, 1987, 1994, 1998, 2002). This represents an alternative hypothetical mechanism of coupling between MtCK and ANT without a need for direct transfer of the substrates between ANT and MtCK. Interestingly, this hypothesis focused attention on the role of the mitochondrial outer membrane in the control of mitochondrial function, and foresaw many important aspects of the control of mitochondrial function *in vivo*, but appeared to be insufficient to explain quantitatively the functional coupling between MtCK and ANT.

3.1.2. Mathematical modelling of the functional coupling between MtCK and ANT

Mathematical modelling of the coupling of the MtCK reaction with ANT was used to test both hypotheses – dynamic compartmentation described above and direct transfer of ATP from ANT to MtCK (Figure 6) – to explain the shifts in kinetic

constants of the MtCK reaction caused by oxidative phosphorylation, as shown in Figure 5F and G (Jacobus and Saks, 1982).

The simplest kinetic scheme that was proposed to explain the kinetic data on MtCK-ANT coupling is based on dynamic compartmentation of adenine nucleotides as referred to above (Gellerich *et al.*, 1987). According to this hypothesis, there are metabolite gradients between the solution surrounding isolated mitochondria and the vicinity of the mitochondrial inner membrane in the intermembrane space. Due to the close vicinity of MtCK and ANT at and within the inner mitochondrial membrane, respectively, ATP and ADP are exchanged between MtCK and ANT. The kinetic properties of MtCK and ANT are not changed during interaction, and all the changes in apparent kinetic constants measured in the experiment are due to inability of experimentalists to measure local ATP and ADP concentrations next to these proteins. Since the gradients of ATP and ADP between the surrounding solution and the vicinity of the mitochondrial inner membrane are dependent on the activity of the mitochondria (i.e. are changing), this hypothesis is usually referred to as “dynamic compartmentation” hypothesis.

To check whether the dynamic compartmentation hypothesis is in correspondence with the data, one could compose a simple mathematical model and compare the model solutions with the experimental data (Vendelin *et al.*, 2004a). To find out whether a set of parameter values exists that can reproduce both dissociation constants for ATP, altered by oxidative phosphorylation at the same time, a number of parameters were varied across the entire allowable range: (a) ATP and ADP exchange coefficients across the outer mitochondrial membrane, (b) ATPase activity, and (c) ANT activity. Regardless of the selected parameter set, the model could not reproduce quantitatively the experimental data obtained in the presence of oxidative phosphorylation (Figure 7A). Thus, it is clear that the dynamic compartmentation hypothesis is not sufficient to reproduce the measurements, and a more complex mechanism of interaction between MtCK and ANT should be used to reproduce the data (Vendelin *et al.*, 2004a). Therefore, the alternative direct local transfer of ATP – generated by oxidative phosphorylation – to MtCK should be considered as a main mechanism of acceleration of aerobic PCr production in heart, skeletal muscle and brain mitochondria.

In mitochondria, ANT transports ADP from the mitochondrial intermembrane space into the matrix space. The stoichiometry of imported ADP to exported ATP is normally one. In mitochondria, the number of MtCK dimers is approximately equal to the number of ANT tetramers (Kuznetsov and Saks, 1986). Irrespective of the exact stoichiometry of ANT/MtCK complexes, the juxtaposition of these molecular entities creates a structural basis for direct transfer (channelling) of metabolites from one entity to the other without dissociation of metabolites into the intermembrane space of mitochondria. ANT in the inner mitochondrial membrane forms tight complexes with negatively charged cardiolipin in a ratio of 1 to 6 (Beyer and Klingenberg, 1985; Beyer and Nuscher, 1996). It has been shown that positively charged MtCK is fixed to this cluster by electrostatic forces due to three C-terminal lysine residues which strongly interact with the negatively

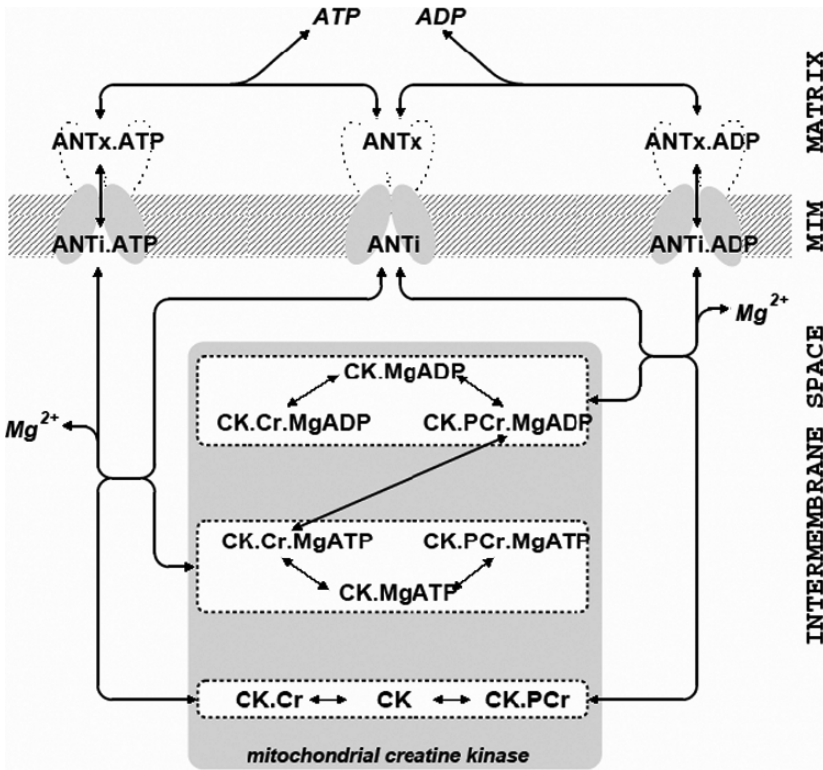

Figure 6. Scheme of interactions between mitochondrial CK (MtCK) and adenine nucleotide translocase (ANT) according to the direct transfer hypothesis. Interaction between the proteins is considered as a sum of two interaction modes: ATP and ADP are transferred through solution or directly channelled between the proteins. In this scheme, only the direct transfer of ATP and ADP between proteins is reflected. In direct transfer mode, ATP is transferred from ANT to MtCK without leaving the two-protein complex into solution. Since MtCK has only one binding site for ATP and ADP, such transfer is possible only if this site is free, i.e. MtCK is either free (“CK”) or has only Cr or PCr bound (“CK.Cr” and “CK.PCr”). In the scheme, we grouped the states of MtCK according to whether ATP or ADP is bound to enzyme or not (white boxes in the scheme with three states of MtCK in each group). During direct transfer of ATP from ANT to MtCK, MtCK is transferred from states CK, CK.Cr, and CK.PCr to states CK.MgATP, CK.Cr.MgATP, and CK.PCr.MgATP, respectively. In the scheme, this transfer is shown as a link between ANTi.ATP and two corresponding groups of MtCK states. Next, after the MtCK reaction (link between states CK.Cr.MgATP and CK.PCr.MgADP in the scheme), ADP is transferred directly to ANT. Note that MtCK operates with Mg-bound ATP and ADP and ANT requires Mg-free ATP and ADP forms. Thus, during direct transfer between MtCK and ANT, Mg is either bound or released, as it is shown in the scheme. This complete scheme was the basis for thermodynamically consistent analysis of coupling (see the text). This figure is reproduced from Vendelin *et al.* (2004a) with permission from the Biophysical Society, USA.

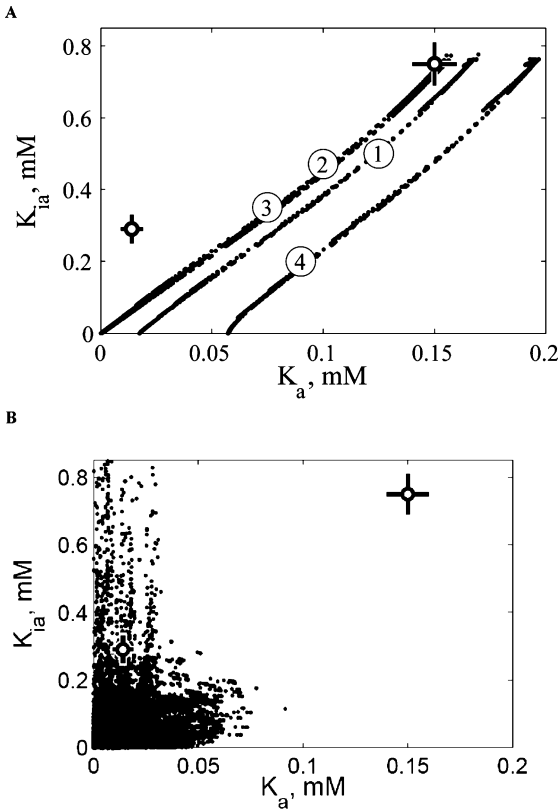

Figure 7. Analyses of the interaction between mitochondrial CK (MtCK) and adenine nucleotide translocase (ANT). (A) Calculated apparent dissociation constants K_a and K_{ia} of the MtCK reaction in the presence of oxidative phosphorylation, with coupling between MtCK and oxidative phosphorylation being modelled according to the dynamic compartmentation hypothesis. The dynamic compartmentation hypothesis assumes that 'interaction' between the proteins is the result of large ATP and ADP gradients between the vicinity of the mitochondrial inner membrane and the solution surrounding the mitochondria. Apparent dissociation constants K_a and K_{ia} (represented by small dots in the figure) were computed for different combinations of ATPase activities (v_{ATPase}) and exchange constants (D_{ATP} and D_{ADP}). The measured values are shown by open circles in the upper right corner (no oxidative phosphorylation) and lower left corner (with oxidative phosphorylation). When using the default kinetic constants of ANT transport, all combinations of computed K_a and K_{ia} values are aligned along line 1. By increasing the maximal activity of ANT 10- or 100-fold, the line can be shifted to the left (lines 2 and 3, respectively). When, instead of increasing the maximal activity of ANT, the apparent dissociation constant for ATP and ADP is increased, the line shifts to the right (line 4). Note that regardless of the used values of ANT kinetic constants, all computed combinations of K_a and K_{ia} were considerably adrift from the measured values in the presence of oxidative phosphorylation. Reproduced from Vendelin *et al.* (2004a) with permission from the Biophysical Society, USA.

(B) Calculated apparent dissociation constants K_a and K_{ia} of MgATP in the MtCK reaction in the presence of oxidative phosphorylation, with coupling between MtCK and oxidative phosphorylation being modelled assuming direct transfer of metabolites between ANT and MtCK. Apparent dissociation constants K_a and K_{ia} (represented by small dots in the figure) were computed for different combinations of free energies of MtCK-ANT complex states and free energies of transition. The measured values are

charged cardiolipin in complex with ANT (Figures 2 and 3) (Muller *et al.*, 1985; Khuchua *et al.*, 1998; Schlattner *et al.*, 2004). The structure of the ANT was recently solved at 2.2 Å resolution by Brandolin's group (Pebay-Peyroula *et al.*, 2003). The translocation of both ATP⁴⁻ and ADP³⁻ in the Mg-free anionic forms is brought about by conformational changes of pore-forming ANT protomers (Pebay-Peyroula *et al.*, 2003). Klingenberg's group suggested that both protomers within an ANT dimer are involved in an alternating manner in the translocation, one accepting for example ATP from the matrix and translocating it towards the intermembrane space, while the second protomer only releases ADP translocated in the previous cycle ("half-site reactivity") (Gropp *et al.*, 1999; Huber *et al.*, 1999; Huang *et al.*, 2001; Brustovetsky *et al.*, 1996). This conformational change ("pore") mechanism leads in its simplest version to a ping-pong reaction mechanism of transport (Huang *et al.*, 2001). On the other hand, the kinetics of ATP-ADP exchange conform to a sequential mechanism involving binding of nucleotides on both sides before transport (Duyckaerts *et al.*, 1980). The structural data of Brandolin's group and the kinetics of ATP-ADP exchange by ANT are fitting well with the hypothesis that the dimers with alternatively activated protomers function in a coordinated manner in oligomeric ANT clusters, where the export of ATP from mitochondria by one protomer in a dimer occurs simultaneously with import of ADP by another protomer in another dimer (Kramer and Palmieri, 1992; Aliev and Saks, 2003; Nuri *et al.*, 2005, 2006).

The functional coupling between MtCK and ANT can be considered as the sum of two interaction modes. In the first mode, ATP and ADP are liberated into the intermembrane space and then bound to MtCK or ANT. This mode corresponds to an 'interaction' between MtCK and ANT as two separate proteins without any coupling (see Figure 6). In this case, ATP as well as all other substrates are in fast equilibrium with MtCK, and the reaction would follow a random Bi-Bi type mechanism. In the second mode, ATP and ADP would be directly channelled between the proteins. Such channelling is possible if the acceptor protein (ANT or MtCK) has no bound ATP or ADP molecule, i.e. it can accept ATP or ADP from the other protein. Additionally, we assume that when MtCK accepts ATP or ADP from ANT directly, bound ATP or ADP cannot be in fast equilibrium with the surrounding solution. Thus, the equilibration of the MtCK binding site for ATP and ADP with the surrounding solution is prevented and the system may have different kinetics if compared with the kinetics of isolated MtCK in solution.

With this model, we were able to reproduce the measured values of apparent kinetic constants of the MtCK reaction. During this test, the free energies of the states of the coupled system were varied as well as the free energies of activation.



Figure 7. shown by open circles in the upper right corner (no oxidative phosphorylation) and lower left corner (with oxidative phosphorylation). Note that the range of computed K_a - K_{ia} combinations covers the area near the measured values of these constants in the presence of oxidative phosphorylation. The figure is reproduced from Vendelin *et al.* (2004b) with permission from the Biophysical Society, USA.

The simulation results are shown in Figure 7B. Note that the region with the measured values of K_a and K_{ia} is covered by the model solutions, and it is possible to find model parameters which lead to the measured combination of K_a and K_{ia} values under conditions of oxidative phosphorylation. One can also reproduce the following experiments with the same set of model parameters: (a) changes in apparent kinetic properties of the MtCK reaction when coupled to oxidative phosphorylation (Jacobus and Saks, 1982; Saks *et al.*, 1985); (b) competition between MtCK-activated mitochondrial respiration and a separate ATP-regenerating system (Gellerich and Saks, 1982); and (c) studies on radioactively labelled adenine nucleotide uptake by mitochondria in the presence of MtCK activity (Barbour *et al.*, 1984). As a result, a free energy profile of the coupled MtCK-ANT system was proposed (Vendelin *et al.*, 2004a). According to our analysis, the main difference in free energy profiles between uncoupled and coupled MtCK-ANT reaction is the free energy change during reaction. In the coupled reaction, due to an increase in the free energy of the $ANT_i \cdot ATP$ state (Figure 6), the free energy decreases when ATP bound to ANT is used to synthesize PCr in the MtCK reaction. If compared with the models of the direct transfer using the probability approach, the proposed mechanism does not require strong changes in the free energy profile of the reaction of phosphate transfer itself (Vendelin *et al.*, 2004a). The proposed detailed kinetic scheme (Figure 6) can be used for further analysis of the kinetics of the MtCK-ANT interaction. In particular, the possible mechanism of an increase in the free energy level of the $ANT_i \cdot ATP$ complex when coupled to oxidative phosphorylation is intriguing and requires further experimental study.

Thus, both structural and functional data available now show convincingly that oxidative phosphorylation controls, via ANT, the MtCK reaction and forces it to produce PCr in spite of unfavourable kinetic and thermodynamic characteristics for this reaction. At the same time, MtCK plays the same role for ANT and oxidative phosphorylation, by channelling back ADP and, thus, directly controlling the rate of respiration.

Experimentally, the role of functional coupling between MtCK and ANT was verified recently in studies on energy metabolism of the heart of MtCK knock-out mice: as predicted by the model described above, these hearts had lower levels of PCr and reduced post-ischemic recovery (Spindler *et al.*, 2002, 2004). A new important role of MtCK-mediated control of ANT is the prevention of opening of the mitochondrial permeability transition pore, as recently discovered by Dolder *et al.* (2003), thereby inhibiting apoptosis and necrosis and, thus, preventing cell death. This illustrates once again the vital importance of the functional coupling phenomenon. Most important new data have recently been published by Meyer *et al.* (2006) showing that the functional coupling between MtCK and ANT strongly decreases production of reactive oxygen species (ROS) in mitochondria. Taking into account that ROS production is now considered a main reason for many age-related diseases and ageing itself (Jezek and Hlavata, 2005), it is difficult to overestimate the importance of these findings.

It is important to stress that the structural and functional coupling between MtCK and ANT does not prevent its participants from working in completely independent modes under some conditions. For example, it is well known that in a medium with only ADP, mitochondria can carry out oxidative phosphorylation without any limitation, despite the structural association of ANT with MtCK. On the other hand, inhibition of oxidative phosphorylation does not result in inhibition of MtCK but only alters its apparent kinetic behaviour (Saks *et al.*, 1975). These facts clearly indicate that the structural association of ANT with MtCK is rather dynamic and does not result in formation of a completely isolated space within these complexes. The substrates and products can leave this space, but can be arrested within to realize functional coupling between the partners, ANT and MtCK.

3.1.3. *Heterogeneity of intracellular diffusion of ADP and the possible role of the outer mitochondrial membrane*

Unusually high values of apparent K_m for exogenous ADP in regulation of the rate of mitochondrial respiration in permeabilized cardiac cells (up to 300–400 μM), as compared to isolated mitochondria (10–20 μM), have been found in many laboratories since 1988 (Saks *et al.*, 1989, 1991, 1993, 1994; Veksler *et al.*, 1995; Kuznetsov *et al.*, 1996; Kay *et al.*, 1997, 2000; Kummel *et al.*, 1988; Anfous *et al.*, 2001; Liobikas *et al.*, 2001; Boudina *et al.*, 2002; Burelle and Hochachka, 2002). Similarly high values of this parameter were found in several other oxidative muscles (Kay *et al.*, 1997; Kaasik *et al.*, 2001), in hepatocytes (Fontaine *et al.*, 1995), but not in fast-twitch skeletal muscles (Veksler *et al.*, 1995; Kuznetsov *et al.*, 1996; Burelle and Hochachka, 2002). Thus, this phenomenon is tissue specific. Figure 8 illustrates these results for isolated adult rat cardiomyocytes. Figure 8A and B show that in isolated mitochondria, respiration is rapidly activated by exogenous ADP in micromolar concentrations, with an apparent $K_m = 17 \mu\text{M}$ (Appaix *et al.*, 2003). When permeabilized cardiomyocytes (Figure 8C) are used, activation of respiration requires addition of exogenous ADP in millimolar concentrations (Figure 8D), with an apparent K_m for ADP of 339 μM . However, in the presence of Cr (20 mM), these kinetics are changed, and the apparent K_m for ADP decreased 3–4-fold due to local production of ADP in the MtCK reaction (Appaix *et al.*, 2003). Figure 8E demonstrates most clearly the strong control of respiration by the MtCK reaction. In these experiments, respiration was activated in permeabilized cardiomyocytes by addition of exogenous MgATP (2 mM) in the presence of 3 mM PEP, and then PK was added in increasing amounts which decreased effectively the respiration rate due to trapping of ADP produced by ATPases. In the presence of this powerful PEP-PK system, stepwise addition of Cr rapidly and maximally activated respiration. Figure 8F shows that increases in PK activity up to 100 IU/ml were not able to suppress Cr-activated respiration. That means that ADP produced in the MtCK reaction coupled to the ANT was not accessible for the powerful ADP trapping system. Interestingly, however, when permeabilized cardiomyocytes were treated with trypsin (Figure 8F), Cr-activated respiration became sensitive to successive additions of PK (Figure 8G). Evidently, digestion by trypsin of some

A

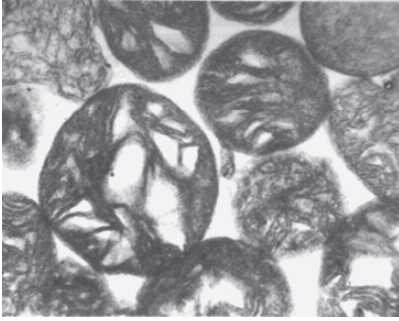

B

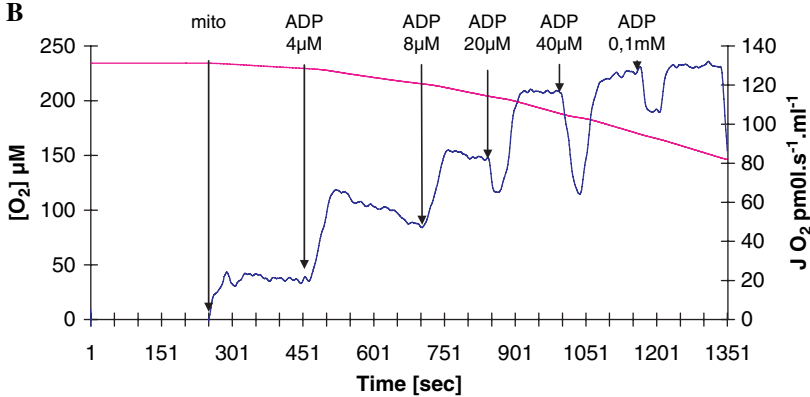
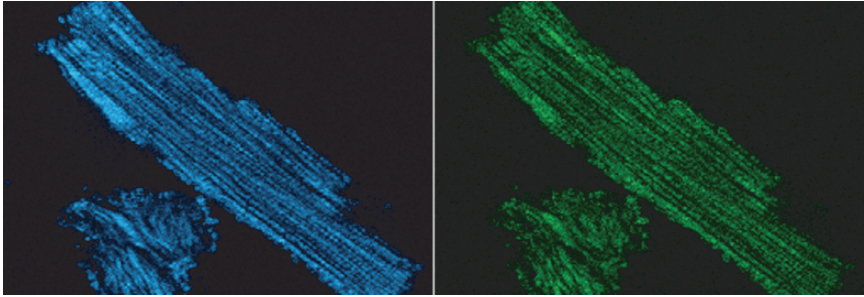
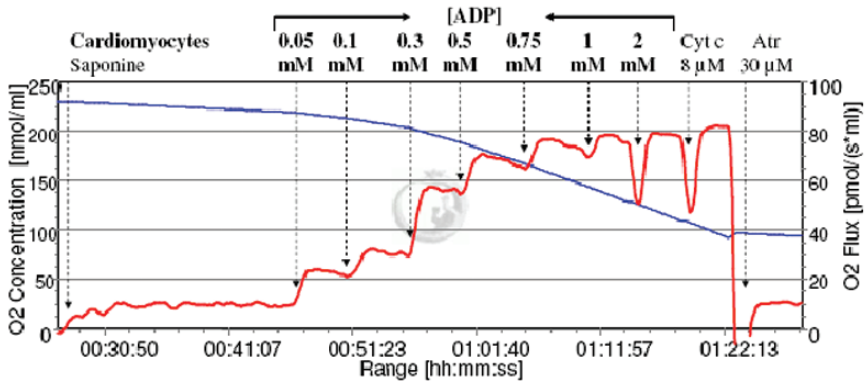

Figure 8. Regulation of respiration by exogenous ADP or ATP and Cr in rat heart mitochondria and permeabilized cardiomyocytes. Respiration rates were recorded using a two-channel high-resolution respirometer (Oroboros oxygraph-2k, Oroboros, Innsbruck, Austria). (A) Electron micrograph of isolated mitochondria. (B) Regulation of respiration of isolated cardiac mitochondria by exogenous ADP. JO_2 = rate of oxygen consumption. (C) Confocal microscopy of permeabilized cardiomyocytes: left: autofluorescence of NADH; right: preloaded with MitoTracker Green. (D) Regulation of respiration in permeabilized cardiomyocytes by exogenous ADP. At the end of the measurement, addition of cytochrome c (Cyt c, 8 μ M) did not change respiration, indicating that the outer membrane was intact. Atractyloside (Atr, 30 μ M) resulted in a decrease in respiration back to V_o due to inhibition of adenine nucleotide translocase. The respiratory control index in this experiment was 6.2. (E) Effective control of respiration by the CK system in permeabilized cardiomyocytes. Respiration was activated by addition of exogenous $MgATP$ in the presence of 3 mM PEP, and then pyruvate kinase (PK) was added in increasing amounts up to 5 IU/ml. In the presence of this powerful PEP-PK system, stepwise addition of Cr maximally activated respiration. (F) Confocal microscopy image of the random arrangement of mitochondria in permeabilized cardiomyocytes preloaded with MitoTracker Red CMX Ros after treatment with trypsin; bar length = 10 μ m; (G) Effect of the competing pyruvate kinase/phosphoenolpyruvate (PEP-PK) system on the relative respiration rate of isolated permeabilized cardiomyocytes initiated by endogenous ADP produced by 2 mM ATP and 20 mM Cr at optimal (0.4 μ M) free $[Ca^{2+}]$ after trypsin treatment (4 °C, 5 min). Trypsin concentrations: 0 nM (●); 25 nM (▲); and 50 nM (■). (A)-(C) have been reproduced from Appaix *et al.* (2003) with kind permission from Experimental Physiology (The Physiological Society and Blackwell Publishing).

C



D



E

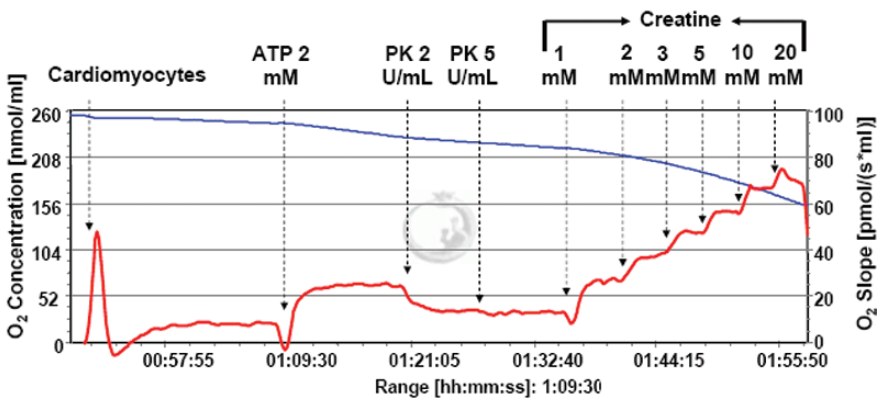

Figure 8. (continued)

F**G**

Figure 8. (continued)

cytoskeletal proteins that normally control mitochondrial positioning also opened the outer membrane for ADP, thus making it possible for some fraction of ADP to leave the intermembrane space and to be trapped by the PEP-PK system, showing that regulation of respiration is dependent on intracellular organization as well as on mitochondrial arrangement and/or integrity.

The high values of apparent K_m for exogenous ADP in permeabilized cardiac cells could be explained by heterogeneity of ADP diffusion inside cells, caused by contacts of mitochondria with the cytoskeleton and other cellular systems and,

thus, by intracellular organization (Saks *et al.*, 2003; Vendelin *et al.*, 2004b). This conclusion was confirmed by results of mathematical modelling, which are described below.

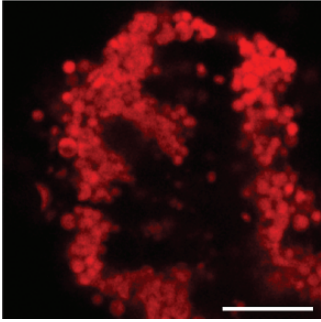
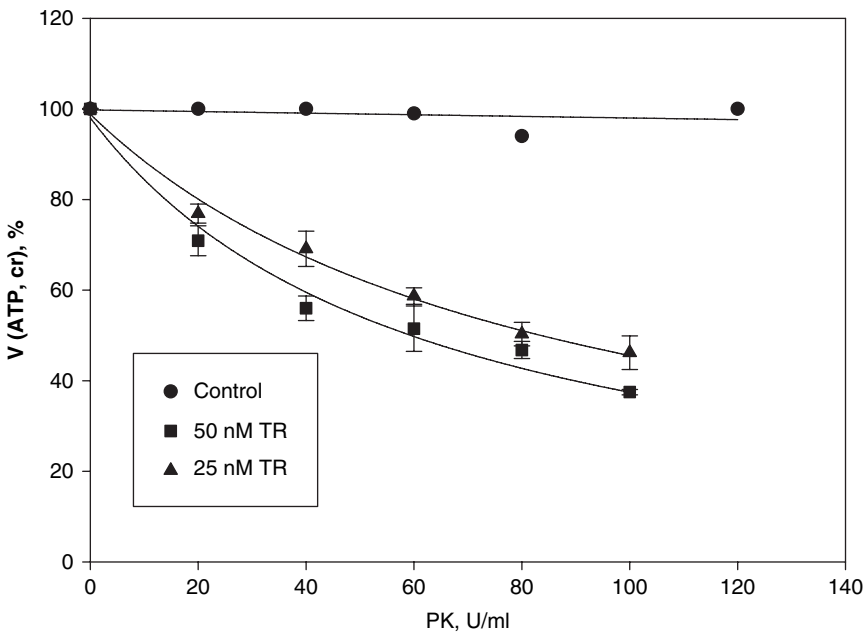
On the way from the surrounding solution to the mitochondrial inner membrane, ATP and ADP molecules encounter two diffusion restrictions. The first one is on the level of the mitochondrial outer membrane and can be regulated by the state of VDAC (Colombini, 2004). The second one is due to macromolecular crowding in the cell. In addition, when simulating experiments performed on permeabilized fibers and cells, the endogenous ATPases have to be taken into account. The complete system used in the model is shown in Figure 9A. The aim of this particular model is to find a set of model parameters that can reproduce the experimental results on stimulation of respiration by exogenously added ADP, as well as on inhibition of respiration by an exogenously added ADP trapping system (PEP-PK). The model was used to determine possible values for two factors describing the restriction of ADP and ATP diffusion: the diffusion factor (DF) and the permeability factor (PF). DF describes the restriction of diffusion of adenine nucleotides within the cytoplasmic (extramitochondrial) space due to macromolecular crowding and cytoskeletal structures, and PF describes the decrease in permeability of the outer mitochondrial membrane due to the control of VDAC by some cytoskeletal proteins (Saks *et al.*, 1994, 1995; Capetanaki, 2002).

Diffusion restrictions between the mitochondrial inner membrane and the external solution influence the apparent K_m for exogenous ADP in regulation of respiration by shifting it to higher values, as referred to above. For example, if there are no considerable diffusion restrictions encountered by molecules between solution and ANT, then respiration should be stimulated by exogenous ADP as in isolated mitochondria. Indeed, when we assume diffusion coefficients equal to those measured in the bulk phase, assuming fast diffusion of nucleotides through the mitochondrial outer membrane, the computed respiration rate is very close to the values measured for isolated mitochondria (open squares in Figure 9B, simulations with large PF values). However, by increasing diffusion restriction imposed by the mitochondrial outer membrane (reduction in PF), the model managed to reproduce data on permeabilized cells and muscle fibers (closed circles in Figure 9B). Similar results can be obtained by reducing the apparent diffusion coefficient DF and by keeping PF at large values (Saks *et al.*, 2003). Thus, the effects of both diffusion restrictions on the model's solution are similar when the measurements of apparent K_m for exogenous ADP are simulated for permeabilized muscle fibers or cells. Therefore, by using only this approach, it is impossible to distinguish between the contributions of the two types of diffusion restrictions.

Determination of diffusion coefficients in muscle tissue yielded about two times lower values than in water (de Graaf *et al.*, 2000). The apparent diffusion coefficients for ADP obtained in the analysis of our data were lower by at least an order of magnitude (Saks *et al.*, 2003). Thus, it seems that there are some diffusion restrictions for ADP which are not visible in overall (average) diffusion coefficient measurements in muscle tissue, but which play an important role in permeabilized

A

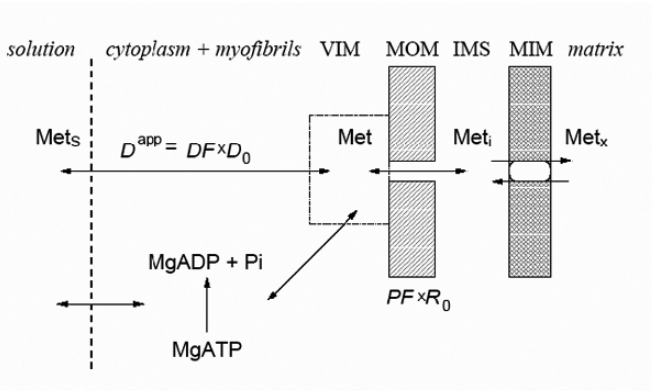

B

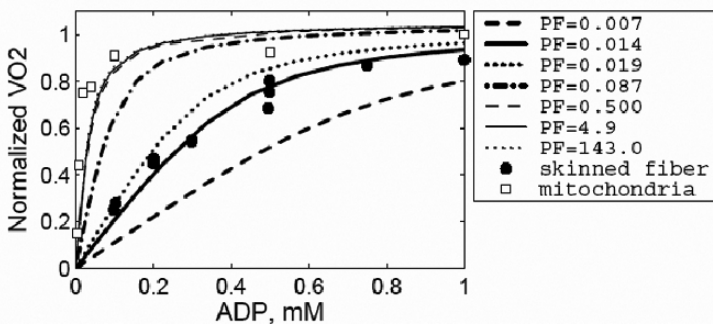

Figure 9. (A) Schematic representation of ADP (and ATP) diffusion pathways from solution into the mitochondrial matrix. Met_s , Met , Met_i , and Met_x are metabolite concentrations in the solution, in the vicinity of the mitochondria (VIM, inside ICEU), in the mitochondrial intermembrane space, and in the mitochondrial matrix, respectively. MOM, IMS, and MIM are mitochondrial outer membrane, intermembrane space, and inner membrane, respectively. D^{app} , D_0 , and DF correspond to the apparent diffusion coefficient, the diffusion coefficient of the metabolite in bulk water phase, and the diffusion factor, respectively (see the text). R_0 is the permeability coefficient for passive diffusion of the metabolite across the outer mitochondrial membrane, and PF is the permeability factor for this metabolite. (B) Analysis of experimental data on regulation of respiration in permeabilized cardiac cells and fibers by mathematical modelling. Dependence of the calculated mitochondrial respiration rate in permeabilized cardiac fibers on the concentration of exogenous ADP computed with different mitochondrial outer membrane permeability factors (PF). The diffusion coefficients of the metabolites within the fiber were taken to be equal to the coefficients measured in bulk water phase of the cells, i.e. no diffusion restriction by macromolecular crowding was imposed. Simulations are compared with measurements of respiration in isolated mitochondria (open squares) and in skinned fibers (solid circles). Note that a reduction in outer membrane permeability increases the apparent K_m (ADP) of mitochondrial respiration. For permeabilized fibers, good fit with the experimental data is obtained for $PF = 0.014$. For isolated mitochondria, good fit is obtained for $PF = 0.5$ and higher. The figure was reproduced from Saks *et al.* (2003) with kind permission from the Biophysical Society, USA.

muscle fiber measurements when mitochondrial respiration rate is used as a probe for local ADP concentrations. Therefore, in addition to the value specifying diffusion restriction for ADP, DF , we tried to estimate the distribution of this restriction throughout the cell (Vendelin *et al.*, 2004b). These simulations indicate that the intracellular diffusion restrictions are not distributed uniformly, but are rather localized in certain areas in the cell (Vendelin *et al.*, 2004b). However, their precise localization is still unknown.

These results are consistent with the conclusions of strong localized diffusion restrictions for ADP and ATP in cardiac cells made by Abraham *et al.* (2002) and Selivanov *et al.* (2004). In particular, these authors studied the metabolic regulation of the sarcolemmal K_{ATP} channel, using both experimental methods and mathematical modelling, and concluded that the ATP diffusion coefficient is decreased in the subsarcolemmal area by several orders of magnitude. Earlier, a similar conclusion was drawn by Weiss and Lamp (1987). By using a microinjection technique, Bereiter-Hahn and Voth (1994) showed that the average diffusion coefficient of ATP in cells was decreased by an order of magnitude. Heterogeneity of ATP diffusion was also evidenced by using a targeted recombinant luciferase technique (Kennedy *et al.*, 1999).

To conclude, a model with localized diffusion restrictions for adenine nucleotides should be considered at present as a first approximation only, and insightful experiments are needed for measurement of local diffusion rates of ATP or ADP by modern experimental techniques. Under conditions of strong local restriction of diffusion of adenine nucleotides, compartmentalized energy transfer by the CK-PCr and other systems is likely to become vitally important for the cell.

3.2. Functionally Coupled MM-creatine Kinases

3.2.1. Myofibrillar creatine kinases

The function and roles of myofibrillar creatine kinase (MM-CK) have been studied and described extensively (Wallimann *et al.*, 1984; Ventura-Clapier *et al.*, 1987, 1998; Krause and Jacobus, 1992; Hornemann *et al.*, 2000, 2003). Wallimann's group has shown that MM-CK is bound specifically to the M-line (Wallimann *et al.*, 1984; Hornemann *et al.*, 2000, 2003), and that significant proportions of this isozyme are found in the space of the I-band of sarcomeres (Wegmann *et al.*, 1992). *In vitro*, the interactions of myosin with CK have been known for a long time (Yagi and Mase, 1962). Studies by Ventura-Clapier *et al.*, (1987, 1998) have shown that PCr accelerates the release of muscle from rigor tension in the presence of exogenous ATP, decreasing the necessary ATP concentration by an order of magnitude. Krause and Jacobus (1982) have shown close functional coupling between the actomyosin ATPase and the CK reaction in isolated rat heart myofibrils, seen as a decrease in the apparent K_m value for ATP from 79.9 ± 13.3 to $13.6 \pm 1.4 \mu\text{M}$ after addition of 12.2 mM of phosphocreatine. In accordance with this finding, Sata *et al.* (1996) found that sliding velocity of fluorescently

labeled actin on a cardiac myosin layer co-immobilized with CK showed a significantly lower apparent K_m value for MgATP than in the absence of CK. Ogut and Brozovich (2003) studied the kinetics of force development in skinned trabeculae from mouse hearts and found that in spite of the presence of 5 mM MgATP, the rate of force development depended on the concentration of PCr, and concluded that there is a direct functional link between the CK reaction and the actomyosin contraction cycle at the step of ADP release in myofibrils. Most probably, this efficient interaction occurs via small microcompartments of adenine nucleotides in myofibrils and is facilitated by anisotropy of their diffusion.

3.2.2. *Membrane-bound creatine kinases*

The role of MM-CK connected to the SR membrane and functionally coupled to the Ca,MgATP-dependent ATPase (SERCA) has been described in detail in many studies (Rossi *et al.*, 1990; Korge *et al.*, 1993; Korge and Campbell, 1994; Minajeva *et al.*, 1996). This coupling has been shown both for isolated SR vesicles and for intact SR in permeabilized cardiac fibers. Addition of PCr increased the rate of calcium uptake and the maximum SR Ca^{2+} content, while the exogenous ATP-regenerating PEP-PK system was less effective (Minajeva *et al.*, 1996). It was also shown in experiments with permeabilized cardiomyocytes that withdrawal of PCr from the medium reduced the frequency and amplitude, but increased the duration of spontaneous Ca^{2+} sparks (Yang and Steele, 2002). Thus, despite the presence of millimolar levels of cytosolic ATP, depletion of PCr impaired Ca^{2+} uptake (Korge *et al.*, 1993; Korge and Campbell, 1994; Minajeva *et al.*, 1996; Yang and Steele, 2002). All these data clearly show the importance of MM-CK, bound to the SR membrane, in rapid rephosphorylation of local MgADP produced in the Ca,MgATPase reaction, independently from the cytoplasmic environment, thus clearly demonstrating that SR-bound MM-CK is acting in a non-equilibrium manner.

An important player in the control of excitation-contraction coupling in the heart is the sarcolemmal membrane metabolic sensor complex. Its main part is the sarcolemmal ATP-sensitive K_{ATP} channel acting as an alarm system to adjust cell electrical activity to the metabolic state of the cell (Lederer and Nichols, 1989; Lorenz and Terzic, 1999; Abraham *et al.*, 2002). ATP closes the channel by interacting with its Kir6.2 subunit, but active membrane ATPases constantly reduce the local ATP concentration, which is distinct from that in the cytosol (Abraham *et al.*, 2002; Crawford *et al.*, 2002). Sarcolemmal MM-CK participates in this system by rephosphorylating local ADP and by maintaining a high ATP/ADP ratio in these microcompartments, with associated impacts on the coordination of membrane electrical activity with cellular metabolic status, and most notably with the PCr level. In this way, the PCr-CK network becomes the main intracellular regulatory pathway for cardiac cells, controlling electrical activity and cell excitability, calcium cycling, contraction and mitochondrial respiration. These energy transfer and control functions are shared by several systems including, besides CK, also the adenylate kinase (AK) and glycolytic systems, as it was seen in

experiments with gene manipulation (Selivanov *et al.*, 2004; Carrasco *et al.*, 2001). MM-CK was first described in purified rat heart sarcolemmal preparations in 1977 (Saks *et al.*, 1977). Later, in experiments involving immunoprecipitation of guinea-pig cardiac membrane fractions with antibodies against the K_{ATP} channel's subunit SUR2, MM-CK was found to be physically associated with the cardiac K_{ATP} channel (Crawford *et al.*, 2002). Due to the sarcolemmal localization of MM-CK, the K_{ATP} channel's closed-open transitions are dependent upon PCr concentration at ATP concentrations higher than the threshold level for channel closure, as shown in experiments with isolated permeabilized cardiomyocytes for open cell-attached patch formation (Abraham *et al.*, 2002; Selivanov *et al.*, 2004). It was also concluded in these studies that strong local restrictions for ATP diffusion exist in the subsarcolemmal area of cardiac cells, which are by-passed by the CK system. This is in good concord with results of studies by Sasaki *et al.* (2001) showing that activation of mitochondrial ATP hydrolysis by uncouplers also activated sarcolemmal K_{ATP} channels in dependence of the activity of the CK system, which could be influenced by its inhibitor, 2,4-dinitrofluorobenzene. Similar functional coupling of CK with the K_{ATP} channel was described for pancreatic β -cells (Krippeit-Drews *et al.*, 2003).

Investigations in Wieringa's laboratory on genetic modification of CK and adenylate kinase (AK) provided firm evidence for the importance of this system: 'knock-outs' of the CK and AK genes result in significant adaptive changes in the cells such as structural remodelling (Janssen *et al.*, 2003; de Groof *et al.*, 2001; Ventura-Clapier *et al.*, 2004; Novatova *et al.*, 2006). A remarkable change associated with a M-CK knock-out was a manifold increase in the volume of the SR system, to compensate for the loss of efficiency of calcium uptake due to the absence of MM-CK (Steeghs *et al.*, 1997).

4. MATHEMATICAL MODELS OF THE PCr CIRCUIT IN HEART CELLS

4.1. Modelling Feedback Metabolic Regulation of Mitochondrial Respiration

The mitochondrial respiration rate *in vivo* may vary 20-fold, from 8–10 $\mu\text{mol min}^{-1} \text{g}^{-1}$ dry mass in resting (KCl-arrested) aerobic hearts to at least 170 $\mu\text{mol min}^{-1} \text{g}^{-1}$ dry mass in beating rat hearts (Williamson *et al.*, 1976). As shown by Neely *et al.* (1967, 1972), Williamson *et al.* (1976) and Balaban *et al.* (1986), oxygen consumption of the heart muscle is linearly dependent on the workload under conditions of metabolic stability of the heart. Parallel activation of energy-producing and -consuming processes is not required to explain these observations in the heart muscle if CK compartmentation and the functional coupling mechanisms described above are taken into account. A model of compartmentalized energy transfer in heart muscle cells was initially developed by Aliev and Saks (1997) and later adapted by Vendelin and co-workers (Saks *et al.*, 2003; Vendelin *et al.*, 2000).

Mathematical modelling studies on energy exchange in working cardiac cells have been performed to gain insight into fundamental questions of cellular energetics: 1) is the cellular CK reaction always in equilibrium state during *in vivo* steady-state contractions of cardiac muscle? If so, ADP levels in the cytoplasm could be predicted from measured intracellular metabolite levels. 2) Is mitochondrial high-energy phosphate export *in vivo* mediated by ATP, according to the classical concept, or in the form of PCr, according to the concept of the CK phosphotransfer pathway? 3) Do metabolite levels in the myoplasm oscillate during cardiac contractions *in vivo*? 4) How can the cell maintain its metabolic stability at times when linearly interrelated manifold increases in cardiac work and oxygen consumption take place at practically constant metabolite levels and PCr/ATP ratios in the cells? In the absence of experimental methods for direct monitoring of cellular ADP levels, mathematical modelling of dynamic events in the cellular cytoplasm remains the only option.

4.2. Description of a Model

A new class of dynamic mathematical models of intracellular compartmentalized energy transport in cardiac cells was constructed, leading ultimately to the formulation of the “Intracellular Energetic Unit” (ICEU) concept (Saks *et al.*, 2001; Seppet *et al.*, 2001). These models are based mainly on the principles of chemical kinetics and the mass action law (Aliev and Saks, 1997; Dos Santos *et al.*, 2000). In addition, they consider the time dynamics of basic events of cellular energetics: ATP hydrolysis by actomyosin ATPase during a contraction cycle; diffusional exchange of metabolites between myofibrillar and mitochondrial compartments; VDAC-restricted diffusion of ATP and ADP across the mitochondrial outer membrane; mitochondrial synthesis of ATP by ATP synthase; P_i and ADP transport into the mitochondrial matrix controlled by the mitochondrial membrane potential, which is a function of ΔpH and $\Delta\Psi$; and PCr production in the coupled MtCK reaction and its utilization by cytoplasmic CKs. These factors are considered in a system consisting of a myofibril with a radius of $1\ \mu\text{m}$, a mitochondrion, and a thin layer of cytoplasm interposed between them (Aliev and Saks, 1997; Dos Santos *et al.*, 2000). The computations of diffusion and chemical events were performed for every $0.1\text{-}\mu\text{m}$ segment of the chosen diffusion path at each $0.01\ \text{ms}$ time step (Aliev and Saks, 1997). This allowed simulation of space-dependent changes throughout the entire cardiac cycle. This system, with adjacent ADP-producing systems in myofibrils and in the SR, is supposed to represent the basic pattern of organization of muscle cell energy metabolism, the ICEU of cardiac cell energetics (see above).

In mitochondria, the ANT and the P_i carrier control the matrix concentrations of ATP, ADP and P_i available for ATP synthase. These carriers establish constant positive (i.e., higher concentration inside) ADP and P_i gradients between the mitochondrial matrix and intermembrane space. In the model, the ATP/ADP ratios in the matrix and the activity of ATP synthase are dependent on $\Delta\Psi$, the electric component of the mitochondrial membrane potential. The model also employs a complete mathematical description of the P_i carrier based on a probability

approach, allowing prediction of the dynamics of P_i accumulation in the matrix in exchange for matrix OH^- ions, i.e. at the expense of mitochondrial proton-motive force, ΔpH . The model considers CK compartmentation as discussed above. In particular, cytoplasmic CK (MM-CK) molecules, representing 69% of total CK activity, are freely distributed in the myofibrillar and cytoplasmic spaces. The intrinsic thermodynamic parameters of MM-CK favour its functioning in the reverse direction of the CK reaction to transphosphorylate ADP to ATP at the expense of PCr utilization. The remaining part of cellular CK, i.e. the MtCK isoenzyme, is localized in the mitochondrial compartment. In mitochondria, MtCK is tightly anchored by cardiolipin molecules to the ANT at the outer surface of the inner mitochondrial membrane. The resulting close proximity of MtCK and ANT allows direct channelling of adenine nucleotides between their adjacent active sites; this channelling is the actual base for shifting the MtCK reaction towards synthesis of PCr from translocase-supplied ATP, even at high levels of ATP in the myoplasm of *in vivo* heart cells.

Mathematical modelling of the cellular CK circuit system was developed further by (i) more sophisticated modelling of the kinetics of mitochondrial ANT by a probability approach and (ii) a simplified modelling approach for the functional coupling between ANT and MtCK (see below). In both versions of the model (Aliev and Saks, 1997; Dos Santos *et al.*, 2000), functional coupling of MtCK to ANT was simulated by means of dynamically changing high local ATP concentrations in a 10-nm narrow space (microcompartment) between coupled molecules. This simplified approach – coupling by local dynamic compartmentation – was used because of a high demand for computing power in the original probability model of coupling. The probability model was used to check the validity of calculations in this simplified approach (Aliev and Saks, 1997).

A distinctive feature of this modelling approach is that we avoided, as much as possible, the formal description of chemical phenomena by adjustable mathematical terms. The living cell is a self-regulating chemical machine; therefore, relying on the principles of chemical and enzyme kinetics decreases the probability of errors during mathematical modelling. Proper choice of maximum rates of enzyme activities, taken from *in vivo* and biochemical data (Aliev and Saks, 1997), also served this goal. All details of modelling can be found in our publications (Aliev and Saks, 1997; Dos Santos *et al.*, 2000).

4.3. Main Results: Mathematical Evidence for the Phosphocreatine Circuit

Modelling revealed oscillations of all metabolite levels in the cytoplasm of the working heart (Figure 10A). Activation of contraction results in a small spike-like, transient (40 ms) decrease in ATP concentration and a symmetrical increase in ADP levels in the systole, followed by more pronounced and longer-lasting changes in PCr (transient decrease) and Cr (transient increase) concentrations. P_i concentrations change in a similar manner as free Cr concentrations (Aliev and Saks, 1997; Dos Santos *et al.*, 2000).

A

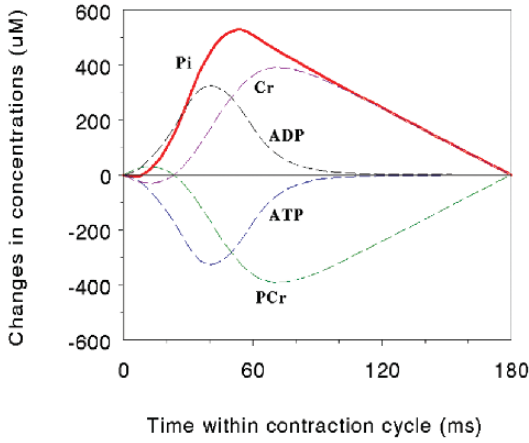

B

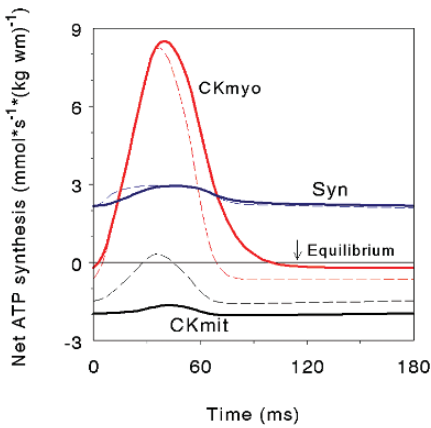

Figure 10. (A) Phasic changes in metabolite concentrations in a myofibril's core during a cardiac contraction cycle. Modelling for a high workload corresponding to a rate of oxygen consumption of $46 \mu\text{atoms of O} \cdot (\text{g} \cdot \text{wm})^{-1} \cdot \text{min}^{-1}$. (B) Modelling results of non-equilibrium behaviour of ATP-synthase (Syn), myofibrillar and mitochondrial CK (CKmyo and CKmit, respectively) under conditions with (solid lines) or without (dotted lines) restrictions for adenine nucleotide diffusion through the mitochondrial outer membrane. An arrow indicates the equilibrium position, when net ATP production is equal to zero. Reproduced from Aliev and Saks (1997) with kind permission from the Biophysical Society, USA.

These metabolite changes are the basis for respective changes in the corresponding chemical reactions. At very high workload, corresponding to a rate of oxygen consumption of $46 \mu\text{ atoms of O} \cdot (\text{g wet mass})^{-1} \cdot \text{min}^{-1}$, an increase in myoplasmic ADP concentration from basal diastolic levels (383 vs. $58 \mu\text{M}$) is responsible for activation of net ATP synthesis by MM-CK from -0.2 to $8.5 \text{ mmol ATP} \cdot \text{s}^{-1} \cdot (\text{kg wet mass})^{-1}$ (Aliev and Saks, 1997) (Figure 10B).

The simulation data indicate that myoplasmic MM-CK is clearly out of equilibrium in cyclically contracting cells (Figure 10B). Non-equilibrium behaviour of MM-CK is caused by cyclic increases in myoplasmic ADP levels during the systole of the cell. These oscillations cannot be dampened completely even when the activity of MM-CK is increased artificially by 10-fold (Saks and Aliev, 1996).

In such a system, based on published experimental data, regeneration of consumed myoplasmic PCr takes place mostly in mitochondria, as evidenced by a permanent shift of the MtCK reaction towards net PCr and ADP synthesis (Aliev and Saks, 1997) (Figure 10B). The mean value of net PCr synthesis in the mitochondrial compartment is $1.91 \text{ mmol PCr} \cdot \text{s}^{-1} \cdot (\text{kg wet mass})^{-1}$. The sustained shift of the MtCK reaction towards PCr synthesis results both from local coupling of MtCK to ANT and from dynamic compartmentation imposed by restrictions for ADP diffusion through the mitochondrial outer membrane. The relative contribution of the former mechanism, i.e. local coupling, to this phenomenon is about 54%: in the same system, but without restrictions for ADP diffusion (Aliev and Saks, 1997), the mean value of net PCr synthesis by mitochondria drops to $1.03 \text{ mmol PCr} \cdot \text{s}^{-1} \cdot (\text{kg wet mass})^{-1}$ (Figure 11).

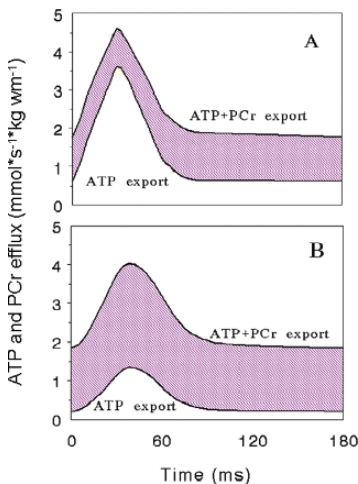

Figure 11. Modelling results of diffusional ATP and PCr export through the mitochondrial outer membrane under conditions without (A) or with (B) restrictions for adenine nucleotide diffusion through the mitochondrial outer membrane. The shaded area indicates PCr efflux. Reproduced from Aliev and Saks (1997) with kind permission from the Biophysical Society, USA.

As a whole, in a system with compartmentalized CK, the functional local coupling of CK to ANT leads to complete separation of functional roles of cellular CK isoenzymes: MM-CK becomes responsible for ATP regeneration in the myoplasm during the systole at the expense of PCr breakdown, while regeneration of myoplasmic Cr to PCr takes place in mitochondria in the coupled MtCK reaction throughout the contraction-relaxation cycle (Figure 11). Such a separation of functions is important for realization of metabolic stability of the working heart (Dos Santos *et al.*, 2000; Aliev *et al.*, 2003)

ACKNOWLEDGEMENTS

This work was supported by INSERM, France, and by grants from the Estonian Science Foundation (no. 7117 and 6142 to V.S.), the Swiss National Science Foundation (grant 3100AO-102075 to T.W. and U.S.), the Swiss Heart Foundation (to T.W. and U.S.) and the Russian Foundation for Basic Science (grant 060448620 to M.A.). Due to space limitations, as well as restriction of cited references, we apologize to all those colleagues and researchers in the field whose work is not directly cited here.

REFERENCES

- Abraham, M.R., Selivanov, V.A., Hodgson, D.M., Pucar, D., Zingman, L.V., Wieringa, B., Dzeja P. Alekseev, A.E., and Terzic, A., 2002, Coupling of cell energetics with membrane metabolic sensing. Integrative signaling through creatine kinase phosphotransfer disrupted by M-CK gene knock-out. *J. Biol. Chem.* **277**: 24427–24434.
- Aliev, M.K., and Saks, V.A., 1997, Compartmentalised energy transfer in cardiomyocytes. Use of mathematical modeling for analysis of in vivo regulation of respiration. *Biophys. J.* **73**: 428–445.
- Aliev, M.K., and Saks, V.A., 2003, Analysis of mechanism of work of mitochondrial adenine nucleotide translocase using mathematical models. *Biofizika (Russian)* **48**: 1075–1085.
- Aliev, M.K., Dos Santos, P., and Saks, V.A., 2003, Mathematical modeling of regulation of oxidative phosphorylation in cardiomyocytes. In: Kekelidze, T., and Holtzman, D. (eds.), *Creatine Kinase and Brain Energy Metabolism. Function and Disease*. IOS Press, Amsterdam, NATO Science Series: Life and Behavioral Sciences, Volume 342: 59–79.
- Ames, A.3rd, 2000, CNS energy metabolism as related to function. *Brain Res. Rev.* **34**: 42–68.
- Anflous, K., Armstrong, D.D., and Craigen, W.J., 2001, Altered mitochondrial sensitivity for ADP and maintenance of creatine-stimulated respiration in oxidative striated muscles from VDAC1-deficient mice. *J. Biol. Chem.* **276**: 1954–1960.
- Appaix, F., Kuznetsov, A.V., Usson, Y., Andrienko, T., Olivares, J., Kaambre, T., Sikk, P., Margreiter, R., and Saks, V., 2003, Possible role of cytoskeleton in intracellular arrangement and regulation of mitochondria. *Exp. Physiol.* **88**: 175–190.
- Balaban, R.S., Kantor, H.L., Katz, L.A., and Briggs, R.W., 1986, Relation between work and phosphate metabolite in the in vivo paced mammalian heart. *Science* **232**: 1121–1123.
- Barbour, R.L., Ribaldo, J., and Chan, S.H.P., 1984, Effect of creatine kinase activity on mitochondrial ADP/ATP transport. Evidence for functional interaction. *J. Biol. Chem.* **259**: 8246–8251.
- Belitzer, V.A., and Tsybakova, E.T., 1939, Sur le mécanisme des phosphorylations couplées avec la respiration. *Biochimia (Russian)* **4**: 516–535.
- Bereiter-Hahn, J., and Voth, M., 1994, Dynamics of mitochondria in living cells: shape changes, dislocations, fusion, and fission of mitochondria. *Microsc. Res. Tech.* **27**: 198–219.

- Bessman, S.P., and Fonyo, A., 1966, The possible role of the mitochondrial bound creatine kinase in regulation of mitochondrial respiration. *Biochem. Biophys. Res. Commun.* **22**: 597–602.
- Bessman, S.P., and Geiger, P., 1981, Transport of energy in muscle: the phosphocreatine shuttle. *Science* **211**: 448–452.
- Beyer, K., and Klingenberg, M., 1985, ADP/ATP carrier protein from beef heart mitochondria has high amounts of tightly bound cardiolipin, as revealed by ^{31}P nuclear magnetic resonance. *Biochemistry* **24**: 3821–3826.
- Beyer, K., and Nuscher, B., 1996, Specific cardiolipin binding interferes with labeling of sulfhydryl residues in the adenosine diphosphate/adenosine triphosphate carrier protein from beef heart mitochondria. *Biochemistry* **35**: 15784–15790.
- Boudina, S., Laclau, M.N., Tariosse, L., Daret, D., Gouverneur, G., Boron-Adele, S., Saks, V.A., and Dos Santos, P., 2002, Alteration of mitochondrial function in a model of chronic ischemia in vivo in rat heart. *Am. J. Physiol.* **282**: H821–H831.
- Brustovetsky, N., Becker, A., Klingenberg, M., and Bamberg, E., 1996, Electrical currents associated with nucleotide transport by the reconstituted mitochondrial ADP/ATP carrier. *Proc. Natl. Acad. Sci. U.S.A.* **93**: 664–668.
- Burelle, Y., and Hochachka, P.W., 2002, Endurance training induces muscle-specific changes in mitochondrial function in skinned muscle fibers. *J. Appl. Physiol.* **92**: 2429–2438.
- Burklen, T.S., Schlattner, U., Homayouni, R., Gough, K., Rak, M., Szeghalmi, A., and Wallimann, T., 2006, The creatine kinase/creatine connection to Alzheimer's disease: CK-inactivation, APP-CK complexes and focal creatine deposits. *J. Biomed. Biotechnol.* **2006**: 1–11.
- Capetanaki, Y., 2002, Desmin cytoskeleton: a potential regulator of muscle mitochondrial behavior and function. *Trends Cardiovasc. Med.* **12**: 339–348.
- Carrasco, A.J., Dzeja, P.P., Alekseev, A.E., Pucar, D., Zingman, L.V., Abraham, M.R., Hodgson, D., Bienengraeber, M., Puceat, M., Janssen, E., Wieringa, B., and Terzic, A., 2001, Adenylate kinase phosphotransfer communicates cellular energetic signals to ATP-sensitive potassium channels. *Proc. Natl. Acad. Sci. U.S.A.* **98**: 7623–7628.
- Cleland, W.W., 1963, The kinetics of enzyme-catalyzed reactions with two or more substrates or products. I. Nomenclature and rate equations. *Biochim. Biophys. Acta* **67**: 104–137.
- Colombini, M., 2004, VDAC: the channel at the interface between mitochondria and the cytosol. *Mol. Cell. Biochem.* **256**: 107–115.
- Crawford, R.M., Ranki, H.J., Botting, C.H., Budas, G.R., and Jovanovic, A., 2002, Creatine kinase is physically associated with the cardiac ATP-sensitive K^+ channel *in vivo*. *FASEB J.* **16**: 102–104.
- De Furia, R.A., Ingwall, J.S., Fossel, E., and Dygert, M., 1980, The integration of isoenzymes for energy distribution. In: Jacobus, W.E., and Ingwall, J.S. (eds.), *Heart creatine kinase*, Williams & Wilkins, Baltimore-London, pp. 135–142.
- Dolder, M., Walzel, B., Speer, O., Schlattner, U., and Wallimann, T., 2003, Inhibition of the mitochondrial permeability transition by creatine kinase substrates. Requirement for microcompartmentation. *J. Biol. Chem.* **278**: 17760–17766.
- Dos Santos, P., Aliev, M.K., Dirolez, P., Duclos, F., Bonoron-Adele, S., Besse, P., Canioni, P., Sikk, P., and Saks, V.A., 2000, Metabolic control of contractile performance in isolated perfused rat heart. Analysis of experimental data by reaction:diffusion mathematical model. *J. Mol. Cell. Cardiol.* **32**: 1703–1734.
- Duyckaerts, C., Sluse-Coffart, C.M., Fux, J.P., Sluse, F.E., and Liebecq, C., 1980, Kinetic mechanism of the exchanges catalysed by the adenine nucleotide carrier. *Eur. J. Biochem.* **106**: 1–6.
- Dzeja, P.P., Zeleznikar, R.J., and Goldberg, N.D., 1998, Adenylate kinase: kinetic behaviour in intact cells indicates it is integral to multiple cellular processes. *Mol. Cell. Biochem.* **184**: 169–182.
- Dzeja, P., and Terzic, A., 2003, Phosphotransfer networks and cellular energetics. *J. Exp. Biol.* **206**: 2039–2047.
- Eband, R.F., Tokarska-Schlattner, M., Schlattner, U., Wallimann, T., and Eband, R.M., 2007, Cardiolipin clusters and membrane domain formation induced by mitochondrial proteins. *J. Mol. Biol.* **365**: 968–980.

- Eband, R.F., Schlattner, U., Wallimann, T., Lacombe, M.L., and Eband, R.M., 2006, Novel lipid transfer property of two mitochondrial proteins that bridge the inner and outer membranes. *Biophys. J.* **92**: 126–137.
- Eppenberger, H.M., Dawson, D.M., and Kaplan, N.O., 1967, The comparative enzymology of creatine kinases. *J. Biol. Chem.* **242**: 204–209.
- Fontaine, E.M., Keriell, C., Lantuejoul, S., Rigoulet, M., Leverve, X.M., and Saks, V.A., 1995, Cytoplasmic cellular structures control permeability of outer mitochondrial membrane for ADP and oxidative phosphorylation in rat liver cells. *Biochem. Biophys. Res. Commun.* **213**: 138–146.
- Fritz-Wolf, K., Schnyder, T., Wallimann, T., and Kabsch, W., 1996, Structure of mitochondrial creatine kinase. *Nature* **381**: 341–345.
- Gellerich, F., and Saks, V.A., 1982, Control of heart mitochondrial oxygen consumption by creatine kinase: the importance of enzyme localization. *Biochem. Biophys. Res. Commun.* **105**: 1473–1481.
- Gellerich, F.N., Schlame, M., Bohnensack, R., and Kunz, W., 1987, Dynamic compartmentation of adenine nucleotides in the mitochondrial intermembrane space of rat-heart mitochondria. *Biochim. Biophys. Acta* **890**: 117–126.
- Gellerich, F.N., Kapischke, M., Kunz, W., Neumann, W., Kuznetsov, A., Brdiczka, D., and Nicolay, K., 1994, The influence of the cytosolic oncotic pressure on the permeability of the mitochondrial outer membrane for ADP: implications for the kinetic properties of mitochondrial creatine kinase and for ADP channeling into the intermembrane space. *Mol. Cell. Biochem.* **133/134**: 85–104.
- Gellerich, F.N., Laterveer, F.D., Korzeniewski, B., Zierz, S., and Nicolay, K., 1998, Dextran strongly increases the Michaelis constants of oxidative phosphorylation and of mitochondrial creatine kinase in heart mitochondria. *Eur. J. Biochem.* **254**: 172–180.
- Gellerich, F.N., Laterveer, F.D., Zierz, S., and Nicolay, K., 2002, The quantitation of ADP diffusion gradients across the outer membrane of heart mitochondria in the presence of macromolecules. *Biochim. Biophys. Acta* **1554**: 48–56.
- de Graaf, R.A., van Kranenburg, A., and Nicolay, K., 2000, In vivo ³¹P-NMR diffusion spectroscopy of ATP and phosphocreatine in rat skeletal muscle. *Biophys. J.* **78**: 1657–1664.
- de Groof, A.J., Smeets, B., Groot Koerkamp, M.J., Mul, A.N., Janssen, E.E., Tabak, H.F., and Wieringa, B., 2001, Changes in mRNA expression profile underlie phenotypic adaptations in creatine kinase-deficient muscles. *FEBS Lett.* **506**: 73–78.
- Gropp, T., Brustovetsky, N., Klingenberg, M., Müller, V., Fendler, K., and Bamberg, E., 1999, Kinetics of electrogenic transport by the ADP/ATP carrier. *Bioophys. J.* **77**: 714–726.
- Haas, R.C., and Strauss, A.W., 1990, Separate nuclear genes encode sarcomere-specific and ubiquitous human mitochondrial creatine kinase isoenzymes. *J. Biol. Chem.* **265**: 6921–6927.
- Hornemann, T., Stolz, M., and Wallimann, T., 2000, Isoenzyme-specific interaction of muscle-type creatine kinase with the sarcomeric M-line is mediated by NH₂-terminal lysine charge-clamps. *J. Cell Biol.* **149**: 1225–1234.
- Hornemann, T., Kempa, S., Himmel, M., Hayess, K., Furst, D.O., and Wallimann, T., 2003, Muscle-type creatine kinase interacts with central domains of the M-band proteins myomesin and M-protein. *J. Mol. Biol.* **332**: 877–887.
- Huang, S.G., Odoy, S., and Klingenberg, M., 2001, Chimers of two fused ADP/ATP carrier monomers indicate a single channel for ADP/ATP transport. *Arch. Biochem. Biophys.* **394**: 67–75.
- Huber, T., Klingenberg, M., and Beyer, K., 1999, Binding of nucleotides by mitochondrial ADP/ATP carrier as studied by ¹H nuclear magnetic resonance spectroscopy. *Biochemistry* **38**: 762–769.
- Jacobus, W.E., and Lehninger, A.L., 1973, Creatine kinase of rat mitochondria. Coupling of creatine phosphorylation to electron transport. *J. Biol. Chem.* **248**: 4803–4810.
- Jacobus, W.E., and Saks, V.A., 1982, Creatine kinase of heart mitochondria: changes in its kinetic properties induced by coupling to oxidative phosphorylation. *Arch. Biochem. Biophys.* **219**: 167–178.
- Janssen, E., Terzic, A., Wieringa, B., and Dzeja, P., 2003, Impaired intracellular energy communication in muscles from creatine kinase and adenylate kinase (M-CK/AK1) double knock-out mice. *J. Biol. Chem.* **278**: 30441–30449.
- Jezek, P., and Hlavata, L., 2005, Mitochondria in homeostasis of reactive oxygen species in cell, tissues and organism. *Intl. J. Biochem.* **37**: 2478–2503.

- Kaasik, A., Veksler, V., Boehm, E., Novotova, M., Minajeva, A., and Ventura-Clapier, R., 2001, Energetic crosstalk between organelles. Architectural integration of energy production and utilization. *Circ. Res.* **89**: 153–159.
- Kay, L., Li, Z., Mericskay, M., Olivares, J., Tranqui, L., Fontaine, E., Tiivel, T., Sikk, P., Kaambre, T., Samuel, J.L., Rappaport, L., Usson, Y., Leverve, X., Paulin, D., and Saks, V.A., 1997, Study of regulation of mitochondrial respiration in vivo. An analysis of influence of ADP diffusion and possible role of cytoskeleton. *Biochim. Biophys. Acta* **1322**: 41–59.
- Kay, L., Nicolay, K., Wieringa, B., Saks, V., and Wallimann, T., 2000, Direct evidence for the control of mitochondrial respiration by mitochondrial creatine kinase in oxidative muscle cells in situ. *J. Biol. Chem.* **275**: 6937–6944.
- Kennedy, H.J., Pouli, A.E., Ainscow, E.K., Jouaville, L.S., Rizzuto, R., and Rutter, G.A., 1999, Glucose generates sub-plasma membrane ATP microdomains in single islet beta-cells. Potential role for strategically located mitochondria. *J. Biol. Chem.* **274**: 13281–13291.
- Khuchua, Z.A., Qin, W., Boero, J., Cheng, J., Payne, R.M., Saks, V.A., and Strauss, A.W., 1998, Octamer formation by cardiac sarcomeric mitochondrial creatine kinase is mediated by charged N-terminal residues. *J. Biol. Chem.* **273**: 22990–22996.
- Kim, I.H., and Lee, H.J., 1987, Oxidative phosphorylation of creatine by respiring pig heart mitochondria in the absence of added adenine nucleotides. *Biochem. Int.* **14**: 103–110.
- Klingenberg, M., 1964, Muskelmitochondrien. In: Kramer, K., Krayer, O., Lehnartz, E., Mural, A., and Weber, H.H. (eds.), *Ergebnisse der Physiologie, Biologischen Chemie und Experimentellen Pharmakologie*, Springer Verlag, Berlin-Göttingen-Heidelberg-New York, Vol. 55, pp. 131–189.
- Korge, P., Byrd, S.K., and Campbell, K.B., 1993, Functional coupling between sarcoplasmic-reticulum-bound creatine kinase and Ca^{2+} ATPase. *Eur. J. Biochem.* **213**: 973–980.
- Korge, P., and Campbell, K.B., 1994, Local ATP regeneration is important for sarcoplasmic reticulum Ca^{2+} pump function. *Am. J. Physiol.* **267**: C357–366.
- Kramer, R., and Palmieri, F., 1992, Metabolic carriers in mitochondria. In: *Molecular Mechanisms in Bioenergetics* (Ernster, L., ed.), Elsevier Science Publishers, pp. 359–384.
- Krause, S.M., and Jacobus, W.E., 1992, Specific enhancement of the cardiac myofibrillar ATPase activity by bound creatine kinase. *J. Biol. Chem.* **267**: 2480–2486.
- Krippeit-Drews, P., Backer, M., Dufer, M., and Drews, G., 2003, Phosphocreatine as a determinant of K_{ATP} channel activity in pancreatic β -cells. *Pflugers Arch.* **445**: 556–562.
- Kummel, L., 1988, $\text{Ca}_m\text{MgATPase}$ activity of permeabilized rat heart cells and its functional coupling to oxidative phosphorylation in the cells. *Cardiovasc. Res.* **22**: 359–367.
- Kuznetsov, A.V., and Saks, V.A., 1986, Affinity modification of creatine kinase and ATP-ADP translocase in heart mitochondria: determination of their molar stoichiometry. *Biochem. Biophys. Res. Commun.* **134**: 359–366.
- Kuznetsov, A.V., Tiivel, T., Sikk, P., Kaambre, T., Kay, L., Daneshrad, Z., Rossi, A., Kadaja, L., Peet, N., Seppet, E., and Saks, V.A., 1996, Striking difference between slow and fast twitch muscles in the kinetics of regulation of respiration by ADP in the cells in vivo. *Eur. J. Biochem.* **241**: 909–915.
- Lederer, W.J., and Nichols, C.G., 1989, Nucleotide modulation of the activity of rat heart ATP-sensitive K^+ channels in isolated membrane patches. *J. Physiol.* **419**: 193–211.
- Liobikas, J., Kopustinskiene, D.M., and Toleikis, A., 2001, What controls the outer mitochondrial membrane permeability for ADP: facts for and against the oncotic pressure. *Biochim. Biophys. Acta* **1505**: 220–225.
- Lorenz, E., and Terzic, A., 1999, Physical association between recombinant cardiac ATP-sensitive K^+ channel subunits Kir.6 and SUR2A. *J. Mol. Cell. Cardiol.* **31**: 425–434.
- McLeish, M.J., and Kenyon, G.L., 2005, Relating structure to mechanism in creatine kinase. *Crit. Rev. Biochem. Mol. Biol.* **40**: 1–20.
- Meyer, L.E., Machado, L.B., Santiago, A.P.S.A., da-Silva, S., De Felice, F.G., Holub, O., Oliveira, M., and Galina, A., 2006, Mitochondrial creatine kinase activity prevents reactive oxygen species generation: Antioxidant role of mitochondrial kinase-dependent ADP re-cycling activity. *J. Biol. Chem.* **281**: 29916–29928.

- Minajeva, A., Ventura-Clapier, R., and Veksler, V., 1996, Ca^{2+} uptake by cardiac sarcoplasmic reticulum ATPase in situ strongly depends on bound creatine kinase. *Pflugers Arch.* **432**: 904–912.
- Muller, M., Moser, R., Cheneval, D., and Carafoli, E., 1985, Cardiolipin is the membrane receptor for mitochondrial creatine phosphokinase. *J. Biol. Chem.* **260**: 3839–3843.
- Neely, J.R., Liebermeister, H., Battersby, E.J., and Morgan, H.E., 1967, Effect of pressure development on oxygen consumption by isolated rat heart. *Am. J. Physiol.* **212**: 804–814.
- Neely, J.R., Denton, R.M., England, P.J., and Randle, P.J., 1972, The effects of increased heart work on the tricarboxylate cycle and its interactions with glycolysis in the perfused rat heart. *Biochem. J.* **128**: 147–159.
- Neely, J.R., and Morgan, H.E., 1974, Relationship between carbohydrate and lipid metabolism and the energy balance of heart muscle. *Annu. Rev. Physiol.* **63**: 413–459.
- Novotova, M., Pavlovieova, M., Veksler, V., Ventura-Clapier, R., and Zahradnik, I., 2006, Ultrastructural remodeling of fast skeletal muscle fibers induced by invalidation of creatine kinase. *Am. J. Physiol. Cell Physiol.* **291**: C1279–1285.
- Nury, H., Dahout-Gonzalez, C., Trezeguet, V., Lauquin, G.J., Brandolin, G., and Pebay-Peyroula, E., 2006, Relations between structure and function of the mitochondrial ADP/ATP carrier. *Annu. Rev. Biochem.* **75**: 713–741.
- Nury, H., Dahout-Gonzalez, C., Trezeguet, V., Lauquin, G., Brandolin, G., and Pebay-Peyroula, E., 2005, Structural basis for lipid-mediated interactions between mitochondrial ADP/ATP carrier monomers. *FEBS Lett.* **579**: 6031–6036.
- Ogut, O., and Brozovich, F.V., 2003, Creatine phosphate consumption and the actomyosin crossbridge cycle in cardiac muscles. *Circ. Res.* **93**: 54–60.
- Opie, L.H., 1998, *The Heart. Physiology, from Cell to Circulation*. Lippincott-Raven Publishers, Philadelphia, USA, pp. 43–63.
- Pebay-Peyroula, E., Dahout-Gonzalez, C., Trézéguet, V., Lauquin, G., and Brandolin, G., 2003, Structure of mitochondrial ADP/ATP carrier in complex with carboxyatractyloside. *Nature* **426**: 39–44.
- Rao, J.K., Bujacz, G., and Wlodawer, A., 1998, Crystal structure of rabbit muscle creatine kinase. *FEBS Lett.* **439**: 133–137.
- Qin, W., Khuchua, Z., Cheng, J., Boero, J., Payne, R.M., and Strauss, A.W., 1998, Molecular characterization of the creatine kinases and some historical perspectives. *Mol. Cell. Biochem.* **184**: 153–167.
- Rossi, A.M., Eppenberger, H.M., Volpe, P., Cotrufo, R., and Wallimann, T., 1990, Muscle-type MM creatine kinase is specifically bound to sarcoplasmic reticulum and can support Ca^{2+} uptake and regulate local ATP/ADP ratios. *J. Biol. Chem.* **265**: 5258–5266.
- Saks, V.A., Chernousova, G.B., Voronkov, U.I., Smirnov, V.N., and Chazov, E.I., 1974, Study of energy transport mechanism in myocardial cells. *Circ. Res.* **35**: 138–149.
- Saks, V.A., Chernousova, G.B., Gukovsky, D.E., Smirnov, V.N., and Chazov, E.I., 1975, Studies of energy transport in heart cells. Mitochondrial isoenzyme of creatine phosphokinase: kinetic properties and regulatory action of Mg^{2+} ions. *Eur. J. Biochem.* **57**: 273–290.
- Saks, V.A., Lipina, N.V., Sharov, V.G., Smirnov, V.N., Chazov, E.I., and Grosse, R., 1977, The localization of the MM isoenzyme of creatine phosphokinase on the surface membrane of myocardial cells and its functional coupling to ouabain-inhibited (Na^+ , K^+)-ATPase. *Biochim. Biophys. Acta* **465**: 550–558.
- Saks, V.A., Kuznetsov, A.V., Kupriyanov, V.V., Miceli, M.V., and Jacobus, W.E., 1985, Creatine kinase of rat heart mitochondria. The demonstration of functional coupling to oxidative phosphorylation in an inner membrane-matrix preparation. *J. Biol. Chem.* **260**: 7757–7764.
- Saks, V.A., Kapelko, V.I., Kupriyanov, V.V., Kuznetsov, A.V., Lakomkin, V.L., Veksler, V.I., Sharov, V.G., Javadov, S.A., Seppet, E.K., and Kairane, C., 1989, Quantitative evaluation of relationship between cardiac energy metabolism and post-ischemic recovery of contractile function. *J. Mol. Cell. Cardiol.* **21**: 67–78.
- Saks, V.A., Belikova, Y.O., and Kuznetsov, A.V., 1991, In vivo regulation of mitochondrial respiration in cardiomyocytes: specific restrictions for intracellular diffusion of ADP. *Biochim. Biophys. Acta* **1074**: 302–311.

- Saks, V.A., Vasilyeva, E., Belikova, Yu.O., Kuznetsov, A.V., Lyapina, S., Petrova, L., and Perov, N.A., 1993, Retarded diffusion of ADP in cardiomyocytes: possible role of mitochondrial outer membrane and creatine kinase in cellular regulation of oxidative phosphorylation. *Biochim. Biophys. Acta* **1144**: 134–148.
- Saks, V.A., Khuchua, Z.A., Vasilyeva, E.V., Belikova, Yu.O., and Kuznetsov, A., 1994, Metabolic compartmentation and substrate channeling in muscle cells. Role of coupled creatine kinases in vivo regulation of cellular respiration - a synthesis. *Mol. Cell. Biochem.* **133/134**: 155–192.
- Saks, V.A., Kuznetsov, A.V., Khuchua, Z.A., Vasilyeva, E.V., Belikova, J.O., Kesvatera, T., and Tiivel, T., 1995, Control of cellular respiration in vivo by mitochondrial outer membrane and by creatine kinase. A new speculative hypothesis: possible involvement of mitochondrial-cytoskeleton interactions. *J. Mol. Cell. Cardiol.* **27**: 625–645.
- Saks, V.A., and Aliev, M.K., 1996, Is there the creatine kinase equilibrium in working heart cells? *Biochem. Biophys. Res. Commun.* **227**: 360–367.
- Saks, V.A., Kaambre, T., Sikk, P., Eimre, M., Orlova, E., Paju, K., Piirsoo, A., Appaix, F., Kay, L., Regiz-Zagrosek, V., Fleck, E., and Seppet, E., 2001, Intracellular energetic units in red muscle cells. *Biochem. J.* **356**: 643–657.
- Saks, V., Kuznetsov, A.V., Andrienko, T., Usson, Y., Appaix, F., Guerrero, K., Kaambre, T., Sikk, P., Lemba, M., and Vendelin, M., 2003, Heterogeneity of ADP diffusion and regulation of respiration in cardiac cells. *Biophys. J.* **84**: 3436–3456.
- Saks, V.A., Vendelin, M., Aliev, M.K., Kekelidze, T., and Engelbrecht, J., 2006a, Mechanisms and modeling of energy transfer between intracellular compartments. In: *Handbook of Neurochemistry and Molecular Neurobiology*, 3rd edition, vol. 5, Neuronal Energy Utilization (Dienel, G., and Gibson, G., eds.), Springer-Verlag, Berlin-Heidelberg, pp. 1–46.
- Saks, V., Dzeja, P., Schlattner, U., Vendelin, M., Terzic, A., and Wallimann, T., 2006b, Cardiac system bioenergetics: metabolic basis of Frank-Starling law. *J. Physiol.* **571**: 253–273.
- Sasaki, N., Sato, T., Marban, E., and O'Rourke, B., 2001, ATP consumption by uncoupled mitochondria activates sarcolemmal K_{ATP} channels in cardiac myocytes. *Am. J. Physiol.* **280**: H1882–H1888.
- Sata, M., Sugiura, S., Yamashita, H., Momomura, S.I., and Serizawa, T., 1996, Coupling between myosin ATPase cycle and creatine kinase cycle facilitates cardiac actomyosin sliding in vitro: a clue to mechanical dysfunction during myocardial ischemia. *Circulation* **93**: 310–317.
- Schlattner, U., Forstner, M., Eder, M., Stachowiak, O., Fritz-Wolf, K., and Wallimann, T., 1998, Functional aspects of the X-ray structure of mitochondrial creatine kinase: a molecular physiology approach. *Mol. Cell. Biochem.* **184**: 125–140.
- Schlattner, U., Eder, M., Dolder, M., Khuchua, Z.A., Strauss, A.W., and Wallimann, T., 2000, Divergent enzyme kinetics and structural properties of the two human mitochondrial creatine kinase isoenzymes. *Biol. Chem.* **381**: 1063–1070.
- Schlattner, U., Gehring, F., Vernoux, N., Tokarska-Schlattner, M., Neumann, D., Marcillat, O., Vial, C., and Wallimann, T., 2004, C-terminal lysines determine phospholipid interaction of sarcomeric mitochondrial creatine kinase. *J. Biol. Chem.* **279**: 24334–24342.
- Schlattner, U., Tokarska-Schlattner, M., and Wallimann, T., 2006, Mitochondrial creatine kinase in human health and disease. *Biochim. Biophys. Acta* **1762**: 164–180.
- Schlattner, U., and Wallimann, T., 2000, Octamers of mitochondrial creatine kinase differ in stability and membrane binding. *J. Biol. Chem.* **275**: 17314–17320.
- Schlattner, U., Dolder, M., Wallimann, T., and Tokarska-Schlattner, M., 2001, Mitochondrial creatine kinase and mitochondrial outer membrane porin show a direct interaction that is modulated by calcium. *J. Biol. Chem.* **276**: 48027–48030.
- Schlattner, U., and Wallimann T., 2004, Metabolite channeling: creatine kinase microcompartments. In: *Encyclopedia of Biological Chemistry* (Lennarz, W.J., and Lane, M.D., eds.), Academic Press, New York, USA, pp. 646–651.
- Schlattner, U., and Wallimann, T., 2006, Molecular structure and function of mitochondrial creatine kinases. In: *Creatine kinase – biochemistry, physiology, structure and function* (Uversky, V.N., ed.), Nova Science Publishers, New York, USA, pp. 123–170.

- Stachowiak, O., Schlattner, U., Dolder, M., and Wallimann, T., 1998, Oligomeric state and membrane binding behaviour of creatine kinase isoenzymes: implications for cellular function and mitochondrial structure. *Mol. Cell. Biochem.* **184**: 141–151.
- Schlegel, J., Wyss, M., Schurch, U., Schnyder, T., Quest, A., Wegmann, G., Eppenberger, H.M., and Wallimann, T., 1988a, Mitochondrial creatine kinase from cardiac muscle and brain are two distinct isoenzymes but both form octameric molecules. *J. Biol. Chem.* **263**: 16963–16969.
- Schlegel, J., Zurbriggen, B., Wegmann, G., Wyss, M., Eppenberger, H.M., and Wallimann, T., 1988b, Native mitochondrial creatine kinase forms octameric structures. I. Isolation of two interconvertible mitochondrial creatine kinase forms, dimeric and octameric mitochondrial creatine kinase: characterization, localization, and structure-function relationships. *J. Biol. Chem.* **263**: 16942–16953.
- Schnyder, T., Rojo, M., Furter, R., and Wallimann, T., 1994, The structure of mitochondrial creatine kinase and its membrane binding properties. *Mol. Cell. Biochem.* **133/134**: 115–123.
- Scholte, H.R., 1973, On the triple localization of creatine kinase in heart and skeletal muscle cells of the rat: evidence for the existence of myofibrillar and mitochondrial isoenzymes. *Biochim. Biophys. Acta* **305**: 413–427.
- Selivanov, V.A., Alekseev, A.E., Hodgson, D.M., Dzeja, P.P., and Terzic, A., 2004, Nucleotide-gated K_{ATP} channels integrated with creatine and adenylate kinases: Amplification, tuning and sensing of energetic signals in the compartmentalized cellular environment. *Mol. Cell. Biochem.* **256/257**: 243–256.
- Seppet, E., Kaambre, T., Sikk, P., Tiivel, T., Vija, H., Kay, L., Appaix, F., Tonkonogi, M., Sahlin, K., and Saks, V.A., 2001, Functional complexes of mitochondria with MgATPases of myofibrils and sarcoplasmic reticulum in muscle cells. *Biochim. Biophys. Acta* **1504**: 379–395.
- Sharov, V.G., Saks, V.A., Smirnov, V. N., and Chazov, E.I., 1977, An electron microscopic histochemical investigation of creatine phosphokinase in heart cells. *Biochim. Biophys. Acta* **468**: 495–501.
- Soboll, S., Conrad, A., and Hebisch, S., 1994, Influence of mitochondrial creatine kinase on the mitochondrial/extramitochondrial distribution of high energy phosphates in muscle tissue: evidence for the leak in the creatine shuttle. *Mol. Cell. Biochem.* **133/134**: 105–115.
- Spindler, M., Niebler, R., Remkes, H., Horn, M., Lanz, T., and Neubauer, S., 2002, Mitochondrial creatine kinase is critically necessary for normal myocardial high-energy phosphate metabolism. *Am. J. Physiol.* **283**: H680–H687.
- Spindler, M., Meyer, K., Stromer, H., Leupold, A., Boehm, E., Wagner, H., and Neubauer, S., 2004, Creatine kinase-deficient hearts exhibit increased susceptibility to ischemia-reperfusion injury and impaired calcium homeostasis. *Am. J. Physiol.* **287**: H1039–H1045.
- Stanley, W.C., Recchia, F.A., and Lopaschuk, G.D., 2005, Myocardial substrate metabolism in the normal and failing heart. *Physiol. Rev.* **85**: 1093–1129.
- Steeghs, K., Benders, A., Oerlemans, F., de Haan, A., Heerschap, A., Ruitenbeek, W., Jost, C., van Deursen, J., Perryman, B., Pette, D., Bruckwilder, M., Koudijs, J., Jap, P., Veerkamp, J., and Wieringa, B., 1997, Altered Ca^{2+} responses in muscles with combined mitochondrial and cytosolic creatine kinase deficiencies. *Cell* **89**: 93–103.
- Taegtmeier, H., Wilson, C.R., Razeghi, P., and Sharma, S., 2005, Metabolic energetics and genetics in the heart. *Ann. N. Y. Acad. Sci.* **1047**: 208–218.
- Veksler, V.I., Kuznetsov, A.V., Anflous, K., Mateo, P., van Deursen, J., Wieringa, B., and Ventura-Clapier, R., 1995, Muscle creatine-kinase deficient mice. II Cardiac and skeletal muscles exhibit tissue-specific adaptation of the mitochondrial function. *J. Biol. Chem.* **270**: 19921–19929.
- Vendelin, M., Kongas, O., and Saks, V., 2000, Regulation of mitochondrial respiration in heart cells analyzed by reaction-diffusion model of energy transfer. *Am. J. Physiol. Cell Physiol.* **278**: C747–C764.
- Vendelin, M., Lemba, M., and Saks, V.A., 2004a, Analysis of functional coupling: mitochondrial creatine kinase and adenine nucleotide translocase. *Biophys. J.* **87**: 696–713.
- Vendelin, M., Eimre, M., Seppet, E., Peet, N., Andrienko, T., Lemba, M., Engelbrecht, J., Seppet, E.K., and Saks, V.A., 2004b, Intracellular diffusion of adenosine phosphates is locally restricted in cardiac muscle. *Mol. Cell. Biochem.* **256/257**: 229–241.

- Vendelin, M., Beraud, N., Guerrero, K., Andrienko, T., Kuznetsov, A.V., Olivares, J., Kay, L., and Saks, V.A., 2005, Mitochondrial regular arrangement in muscle cells: a "crystal-like" pattern. *Am. J. Physiol. Cell Physiol.* **288**: C757–C767.
- Ventura-Clapier, R., Mekhfi, H., and Vassort, G., 1987, Role of creatine kinase in force development in chemically skinned rat cardiac muscle. *J. Gen. Physiol.* **89**: 815–837.
- Ventura-Clapier, R., Kuznetsov, A., Veksler, V., Boehm, E., and Anfous, K., 1998, Functional coupling of creatine kinases in muscles: species and tissue specificity. *Mol. Cell. Biochem.* **184**: 231–247.
- Ventura-Clapier, R., Kaasik, A., and Veksler, V., 2004, Structural and functional adaptations of striated muscles to CK deficiency. *Mol. Cell. Biochem.* **256**: 29–41.
- Vial, C., Godinot, C., and Gautheron, D., 1972, Membranes: creatine kinase (E.C.2.7.3.2.) in pig heart mitochondria. Properties and role in phosphate potential regulation. *Biochimie* **54**: 843–852.
- Wallimann, T., Schlosser, T., and Eppenberger, H., 1984, Function of M-line-bound creatine kinase as intramyofibrillar ATP regenerator at the receiving end of the phosphorylcreatine shuttle in muscle. *J. Biol. Chem.* **259**: 5238–5246.
- Wallimann, T., Wyss, M., Brdiczka, D., Nicolay, K., and Eppenberger, H.M., 1992, Intracellular compartmentation, structure and function of creatine kinase isoenzymes in tissues with high and fluctuating energy demands: the 'phosphocreatine circuit' for cellular energy homeostasis. *Biochem. J.* **281**: 21–40.
- Wallimann, T., and Hemmer, W., 1994, Creatine kinase in non-muscle tissues and cells. *Mol. Cell. Biochem.* **133/134**: 193–220.
- Wallimann, T., Dolder, M., Schlattner, U., Eder, M., Hornemann, T., O'Gorman, E., Ruck, A., and Brdiczka, D., 1998, Some new aspects of creatine kinase (CK): compartmentation, structure, function and regulation for cellular and mitochondrial bioenergetics and physiology. *Biofactors* **8**: 229–234.
- Wegmann, G., Zanolla, E., Eppenberger, H.M., and Wallimann, T., 1992, In situ compartmentation of creatine kinase in intact sarcomeric muscle: the acto-myosin overlap zone as a molecular sieve. *J. Muscle Res. Cell Motil.* **13**: 420–435.
- Weiss, J.N., and Lamp, S.T., 1987, Glycolysis preferentially inhibits ATP-sensitive K⁺ channels in isolated guinea pig cardiac myocytes. *Science* **238**: 67–69.
- Weiss, J.N., Ling, Y., and Qu, Z., 2006, Network perspectives of cardiovascular metabolism. *J. Lipid Res.* **47**: 2355–2366.
- Williamson, J.R., Ford, C., Illingworth, J., and Safer, B., 1976, Coordination of citric acid cycle activity with electron transport flux. *Circ. Res.* **38**: 39–51.
- Williamson, J.R., 1979, Mitochondrial function in the heart. *Annu. Rev. Physiol.* **41**: 485–506.
- Wyss, M., and Kaddurah-Daouk, R., 2000, Creatine and creatinine metabolism. *Physiol. Rev.* **80**: 1107–1213.
- Yagi, K., and Mase, R., 1962, Coupled reaction of creatine kinase and myosin A-adenosine triphosphatase. *J. Biol. Chem.* **237**: 397–403.
- Yang, Z., and Steele, D.S., 2002, Effects of phosphocreatine on SR regulation in isolated saponin-permeabilised rat cardiac myocytes. *J. Physiol.* **539**: 767–777.
- Zhou, G., Somasundaram, T., Blanc, E., Parthasarathy, G., Ellington, W.R., and Chapman, M.S., 1998, Transition state structure of arginine kinase: implications for catalysis of bimolecular reactions. *Proc. Natl. Acad. Sci. U.S.A.* **95**: 8449–8454.